

UNIVERSITE LIBRE DE BRUXELLES

Faculté de Philosophie et Lettres

ETUDE ARCHEOLOGIQUE DU MATERIEL DE LA MISSION
MAURITS BEQUAERT DE 1950-1952 AU BAS-ZAIRE
VOLUME 2

Directeur de mémoire:

Monsieur le professeur P. de MARET

Mémoire présenté en vue de l'obtention
du grade de licencié en Histoire de l'Art
et Archéologie

Sous-section non européen

BERNARD CLIST

Année académique 1981-1982

VOLUME 2

1°PARTIE : INVENTAIRES.

Inventaire céramique: sériation de l'ensemble.

MISENGA: n°s.1 à 235.

Jattes et bols, n°s.1 à 62 et n°128.

Pots ellipsoïdes, n°s.64 à 76 et n°129.

Terrines, n°s.63, 109 et 130.

Pots sphériques type D, col vierge, n°s.77 à 85, n°s.93 à 100.

Pots sphériques type D, col décoré, n°s.101 à 108.

Pots sphériques type E, n°s.86 à 92.

Godets, n°s.111 et 112.

Pot à rebord interne, n°110.

Divers, n°s.113 à 235.

MAN TSE TSI: n°s.236 à 305.

Vases Kay Ladio, n°s.236 à 291.

Divers, n°s.292 à 305.

KINKENGE: vase Kay Ladio n°306.

KINDU II: n°s.307 à 353.

Vases Kay Ladio, n°s.307 à 348.

Divers, n°s.349 à 353.

SUMBI: n°s.354 à 658.

Groupe Sumbi, n°s.354 à 371.

Groupe II, n°s.372 à 374 et n°656.

Vases type Ntadi-Yomba, n°s.655 et 657.

Vases au "filét"; n°s.609 à 654.

Atypiques, n°s.597 à 608 et n°658.

Vases Kay Ladio, n°s.415 à 482, n°484, n°s.487 à 581.

Vases du Groupe VI, n°s.483, 485 et 486.

Divers, n°s.375 à 414.

Fonds de vases, n°s.582 à 596.

1. Inventaire Céramique: (1):

MISENGA:

1	2	3	4	5	6	7	8	9	10	11	12	13	14	15	16
1	70.602-8	0	4	3,3	5,4	-	C3	1	4?+3	19	A	-	0	-	-
2	70.527-1	1	4	3,4	7,0	-	C3	2	1	20	B	-	0	-	pl.3
	70.527-3	"	"	"	"	-	"	"	"	"	"	-	"	-	"
	70.527-4	"	"	"	"	-	"	"	"	"	"	-	"	-	"
3	70.542-1	1	4	6	7,0	-	C3	1	4+3	20	C	-	0	-	pl.3
4	70.527-2	1	4	3,8	7,5	-	C6	2	4+3?	+20	B	-	0	-	pl.3
5	70.601-15	1	5	5,2	6,6	7,9	C6	2	4+3	21	B	-	0	-	pl.3
	70.597-1	"	"	"	"	"	"	"	"	"	"	-	"	-	"
	70.597-15	"	"	"	"	"	"	"	"	"	"	-	"	-	"
	70.597-20	"	"	"	"	"	"	"	"	"	"	-	"	-	"
6	70.546-1	1	4	6,2	6,7	-	C3	1	4+3?	21	D	-	0	-	pl.3
	70.546-3	"	"	"	"	-	"	"	"	"	"	-	"	-	"
7	70.600-1	0	4	4	7,3	-	C8	2	4+3	19	B	-	0	-	-
8	70.537-1	0	4	4	7,6	-	C6	2	4	26	B	-	0	-	-
9	70.528-?	1	5	2,4	8	7,6	C6	1-2	4+3	22	A	-	0	-	pl.1
10	70.531-2	0	4	3	6,4	-	C2	2	4+3	20	A	1	1	[LIIIx]	-
	70.531-3	"	"	"	"	-	"	"	"	"	"	"	"	"	-
11	70.660	1	4	5	12	-	C7	2	4	+25	A	-	9	-	pl.1
12	70.508	1	5	2-3	6,8	-	C7	2	4	15	A	-	0	-	pl.2
13	70.521-3	0	5	4	7,9	6,1	C5	1	4+3	-	B	-	0	-	-
14	70.625-1	1	4	4,4	7,8	-	C6	2	4+3	17	B	0	1	[LIIIx]	pl.2

1	2	3	4	5	6	7	8	9	10	11	12	13	14	15	16
15	70.531-1	0	4	5,8	8	-	C6	2	4+3	21	A	-	0	-	-
16	70.661-4	0	4	8,0	8,6	-	C8	2	4+3	22	-	-	0	-	-
	70.661-2	"	"	"	"	-	"	"	"	"	-	-	"	-	-
17	70.546-2	0	4	5,0	6,8	-	C7	1	4+3	20	B	-	0	-	-
18	70.667-1	0	4	4,3	4,6	-	C6	2	4+3	16	B	-	0	-	-
19	70.601-10	0	4	3,0	6,2	-	C3	1	4+3	-	B	-	0	-	-
20	70.602-2	0	4	4,8	8,3	-	C6	2	4+3+5?	16	C	-	0	-	-
21	70.660-5	0	4	6,2	8,2	-	C3	2	4+3	20	A	-	0	-	-
22	70.542-5	0	4	2,6	5,8	-	C7	2	1	12	C	-	0	-	-
23	70.553-2	0	4	5,0	7,8	-	C7	1	4+3	27	B	-	0	-	-
24	70.605-2	0	4	5,0	8,3	-	C7	2	4+3	22	A	-	0	-	-
25	70.660-16	0	4	3,6	6,7	-	C6	2	4+3	24	A	-	0	-	-
26	70.605-14	0	4	5,4	6,3	-	C3	1	4?+3	16	F	-	0	-	-
27	70.662-1	0	1	-	-	-	C8	1	4+3	-	-	-	0	-	-
28	70.557-6	0	4	5,3	7,7	-	C6	2	4?	-	-	-	0	-	-
29	70.557-16	0	4	5,1	7,7	-	C6	1	4	-	-	-	0	-	-
30	70.667-8	0	4	4,7	6,6	-	C7	1	1	-	-	-	0	-	-
31	70.670-1	0	4	3,7	7,2	-	C6	2	4+3	21	A	-	0	-	-
32	70.549-2	0	4	3,6	7,6	-	C7	1	4+3	24	C	-	0	-	-
	70.551	"	"	"	"	-	"	"	"	"	"	-	"	-	-
33	70.547-1	0	4	4,3	5,3	-	C3	2	4+3	16	A	-	0	-	-
34	70.689	0	4	3,2	7,4	-	C7	1	4+3?	20	B	-	0	-	-
35	70.710-2	0	4	4,3	8,5	-	C7	1	4	19	A	-	0	-	-

1	2	3	4	5	6	7	8	9	10	11	12	13	14	15	16
36	70.679-9	0	4	3,5	7,7	-	C6	2	3+1+4?	16	A	-	0	-	-
37	70.518-2	0	4	3,0	5,3	-	C7	1	4	17	A	-	0	-	-
38	70.691-16	0	4	4,6	4,4	-	C7	1	4	14	D	-	0	-	-
39	70.608-3	0	4	5,5	8,0	-	C6	1	4+3	+19	D	-	0	-	-
	70.608-5	"	"	"	"	-	"	"	"	"	"	-	"	-	-
40	70.691-9	0	4	5,6	7,6	-	C6	2	3+4?	14	B	-	0	-	-
41	70.608-22	0	4	4,3	7,2	-	C6	2	4+3?	24	B	-	0	-	-
	70.608-23	"	"	"	"	-	"	"	"	"	"	-	"	-	-
42	70.691-40	0	4	5,7	8,0	-	C7	2	4+1	17	A	-	0	-	-
43	70.557-16	0	4	4,8	7,0	-	C6	2	4+5	22	A	-	0	-	-
44	70.691-42	0	4	4,2	7,2	-	C7	2	4+1	21	B	-	0	-	-
45	70.679	0	4	3,9	6,0	-	C7	1	4?	16	A	-	0	-	-
46	70.667-8	0	4	4,5	6,3	-	C6	2	(4+1?)	17	B	-	0	-	-
47	70.691	0	4	4,2	7,0	-	C7	2	4	17	D	-	0	-	-
48	70.710-3	0	4	4,4	7,7	-	C7	1	4+3	25	B	-	0	-	-
49	70.667-7	0	4	5,6	6,4	-	C6	2	3	12	D	-	0	-	-
50	70.694-38	0	4	4,6	7,0	-	C7	1	3?	17	D	-	0	-	-
51	70.679-16	0	4	4,5	7,3	-	C7	2	4+3	26	A	-	0	-	-
	70.679-27	"	"	"	"	-	"	"	"	"	"	-	"	-	-
52	70.707-3	0	4	4,4	7,9	-	C6	1	4+3	19	A	-	0	-	-
53	70.528-7	0	4	6,0	7,3	-	C7	1	4+3?	18	A	-	0	-	-
54	70.525-7	0	4	5,3	8,6	-	C6	2	4+3	17	A	-	0	-	-

1	2	3	4	5	6	7	8	9	10	11	12	13	14	15	16
55	70.598-6	0	4	5,3	6,5	-	C8	1	4+1	22	A	-	0	-	-
56	70.710-2	0	2	-	6,3	-	C8	1	4	-	-	1	1	[L III x]	-
57	70.652-100	0	2	-	9,0	-	C7	2	4+3	-	-	1	1	[L III x]	-
58	70.637-74	1	2	-	7,0	-	C8	1	4+3	-	-	1	1	II2b[L III x]	p1.2
59	70.557-7	0	2	-	7,6	-	C6	2	1	-	-	1	1	IIb[L III x]	-
60	70.625-6	1	2	-	4,4	-	C7	2	4+3	-	-	1	1	[L III x]	p1.2
61	70.-29	0	2	-	6,2	-	C6	2	1	-	-	1	1	[L III x]	-
62	70.557-3	0	2	-	5,5	-	C7	1-2	3	-	-	1	1	[L III x]	-
128	70.518-7	1	5	3,0	5,0	6,0	C7	1	4	15	A	-	0	-	p1.2
63	70.662	1	5	7,5	7,3	6,0	C7	1	4	21	E	0	2D	(T IIs)b/(R IIs).	p1.5
	70.520-1	"	"	"	"	"	"	"	"	"	"	"	"	"	"
	70.622	"	"	"	"	"	"	"	"	"	"	"	"	"	"
64	70.681	1	5	5,3	6,0	5,9	C7	1	4	10	E	0	2A	(T IIs Vc IIpt)b/(L IIz Vc IIpt).	p1.6
65	70.524	1	5	5,0	6,3	6,0	C7	1	4+3	15	E	0	2C	(T IIs)b/(L IIz)b/(L IIs)b/T IIz)	p1.6
	70.615	"	"	"	"	"	"	"	"	"	"	"	"	"	"
66	70.645	1	5	6,8	7,3	5,7	C8	1	4	+17	E	1	2C	(II 7t) [(T IIs)b/(L IIz)b/(T IIs)]	p1.6
	70.581	"	"	"	"	"	"	"	"	"	"	"	"	"	"
	70.527-8	"	"	"	"	"	"	"	"	"	"	"	"	"	"
	70.691-51	"	"	"	"	"	"	"	"	"	"	"	"	"	"
67	70.673-1	1	5	5,0	7,2	4,1	C7	1	4+3	+20	E	0	2D	(T IIs)b/(R IIz)b/(T IIs)Vc V	p1.5
	70.673-5	"	"	"	"	"	"	"	"	"	"	"	"	"	"
	70.673-6	"	"	"	"	"	"	"	"	"	"	"	"	"	"
68	70.629	1	6	-	5,0	7,2	C8	1	3	-	-	1	5	(IIst)/b[(IIzu)x(II3su)] .	p1.5

1	2	3	4	5	6	7	8	9	10	11	12	13	14	15	16
69	70.625-10	1	4	6,0	6,0	-	C7	1	3+1	15	E	1	4	(II5t)b/(IIIzu)b/(IIst)b/IIIsu) .	p14
70	70.699-1	1	6	-	7,6	7,0	C8	1	4+1	-	-	1	4	(II5t)/b (III x sz)/b(II4t)/b(III x sz) .	p19
	70.699-2	"	"	"	"	"	"	"	"	"	"	"	"	"	"
71	70.618	1	2	-	5,7	-	C7	1	3+4	-	-	1	4	(IIt>>)b[V]	p14
72	70.693	1	2	-	6,9	-	C8	2	4+5?	15	E	0	2D	(T IIs)b/(R IIz)b/(T IIs?)Vc(III x)	p15
	70.695	"	"	"	"	"	"	"	"	"	"	"	"	"	"
	70.659	"	"	"	"	"	"	"	"	"	"	"	"	"	"
73	70.632	1	4	4,2	5,2	-	C8	2	4+3	18	E	0	5	(IIz)x(II2s).	p15
74	70.668-3	0	-	5,5	-	-	C5	2	3+4?	-	E	1	4	(IIt3)b [(III)V(IIt)]	-
75	70.667-11	0	1	6,1	-	-	C5	2	3+4?	-	E	1	-	IIt5?	-
76	70.-48	0	1	5,0	-	-	C7	2	4+1	-	E	1	-	(I5t?)b[(III+?)]	-
129	70.676-1	1	4	5,1	5,0	-	C7	1	4	-	E	0?	2A	(T IIs)b/(T IIz?)	p14
77	70.653-100	1	5	5,5	5,9	7,0	C8	1	4	12	G	1	3	(II3t)b [C1(IIF)U C2(V)] .	p17
78	70.663-1	1	5	5,0	6,2	6,3	C7	1-2	4?+3	12	B	0	2D	(T IIs V II3ft)b/(R IIz)b/(T IIz)	p17
79	70.625-3	1	5	5,0	6,4	8,4	C8	2	4	17	B	0	2A	(T IIs)b/(T IIz)	p17
80	70.629	1	5	3	4,2	4,3	C7	2	4(+3+5?)14	14	G	0?	-	Impressions au peigne, voir planche	p1.7
81	70.675	1	5	4,2	4,6	4,1	C8	2	4	12	D	1	3	(II3t)b [C1(IIs)U C2(IIF)u C3(II2)]	p1.7
82	70.663-2	0	4	4,3	6,3	-	C7	1	4	15	-	0?	-	IIs	-
83	70.691-11	0	4	3,7	5,4	-	C7	1-2	4	+13	-	0?	3?	C1(IIF)U C2(IIz)	-
84	70.591-1	0	4	-	-	-	C8	2	4+3?	8	-	0	2D	(T IIz)b/(R IIs)	-
85	70.-43	0	2	-	5,3	5,4	C6	2	4+1	-	-	0?	?	-	-
86	70.597-6	0	4	3,9	6,3	-	C8	1	4+3	19	-	0	3?	(IIF)U(IIt).	-
87	70.667-3	0	4	-	6,8	-	C7	1	4	-	-	1	?	IIt	-

1	2	3	4	5	6	7	8	9	10	11	12	13	14	15	16
88	70.691-3	0	4	-	6,0	-	C6	2	4+1?)	-	0	2D	(T IIs)b/(R IIz).	-
89	70.698-1	0	4	-	4,9	-	C7	2	4+3	-	-	0	?	IIF.	-
90	70.658	1	6	-	-	6,6	C8	1	4+3	-	A	0	3?	C1(IIF)U C2(V).	pl.8
91	70.650-100	1	5	4	5,9	6,9	C8	1	4+1	-	A	1	4?	(II6t)b[(T IIs)b/(T IIz)] U C(IIF)	pl.8
92	70.674-1	1	5	5,1	6,6	8,3	C8	1	4	21	A	1	4?	(II7t)b[(T IIs)b/(T IIz)].	pl.8
93	70.679-54	0	4	5,0	5,8	-	C7	2	4+1	11	A	-	-	-	-
94	70.707-90	0	4	4,7	5,2	-	C7	2	4+3	+17	A	-	-	-	-
95	70.611	1	5	4	7,4	8,2	C8	1	4?+1	+24	A	0	-	(T IIs)b/(T IIz).	pl.13
96	70.639	0	4	2,4	5,7	9,9	C7-C8	1	4+1	-	-	0	2?	(T IIs).	-
97	70.537-6	1	4	2,0	4,9	8,3	C8	1	4+3?	+11	G	0	2?	(T IIs).	pl.8
98	70.557-16	1	4	-	4,2	6,0	C8	1	4	+11	A	0	2?	(T IIz)b/(T IIs).	pl.7
99	70.557-25	1	4	1,8	4,2	6,2	C8	1-2	4+3?	-	G	0	3?	C1(IIz)U C2(IIF)	pl.8
100	70.691	1	4	3,6	5,8	7,0	C7	1	4	-	G	1	2?	(IIst)b/(T IIs)?	pl.8
101	70.537-12	0	4	3,0	4,5	-	C8	1	4	11	A	-	-	(IVz x IVs x IVz)	-
102	70.663	1	4	4,4	6,4	-	C7	1	4	18	B	-	-	(IVz x IVs x IVz)	pl.9
103	70.663-17	1	4	3,7	5,9	-	C7	2	4	16	B	-	-	(IVs x IVs)	pl.9
	70.663-18	"	"	"	"	"	"	"	"	"	"	"	"	"	"
104	70.664	1	2	-	5,1	-	C8	2	4	-	E	-	-	(IV Uz)	pl.10
105	70.525-55	0	4	4,4	6,1	-	C7	2	4	-	E	-	-	(IVs x IVz)	-
106	70.537-15	0	4	3,4	5,4	-	C8	1	4	-	E	-	-	(IVs x IVz x IVs)	-
107	70.525-70	0	4	2,7	6,0	-	C7	2	4+3	-	A	-	-	(IVz x IVs x IVz)	-
108	70.679-73	0	4	4,3	4,4	-	C8	1	4+1	13	A	-	-	(IVs x IVz x IVs)	-
109	70.654-1	1	5	3,2	6,7	5,2	C5	2	4+3	16	B	1	2A	(II4t)b[(T IIs)b/(T IIz)]	pl.4

1	2	3	4	5	6	7	8	9	10	11	12	13	14	15	16
110	70.623	1	5	2,6	5,0	6,5	C8	2	4+3	11	A	1	3	(IIIt)b [C1(IIIs x II3z)U C2(IIF)U C3(R IIIs	pl.6
	70.642	"	"	"	"	"	"	"	"	"	"	"	"	b/II3t b/ R IIz)U C4(IIF)U C5(IV)].	
111	70.554	1	5	3	3,4	3,6	C8	1	4	8	G	-	0	-	pl.1
	70.555	"	"	"	"	"	"	"	"	"	"	-	"	-	"
112	70.557	0	5	2,3	2,9	5,6	C5	2	3	-	G	-	0	-	-
113	70.65?-2	1	5	4,2	7,7	6,2	C5	2	3+4?	17	A	0	2C	(T IIIs)b/(L IIz)b/(L IIIs)b/(T IIz?)	pl.13
114	70.844	1	5	7,1	10,0	7,5	C8	1	4	11	A	1	-	Atypique, voir planche.	pl.13
115	70.625-4	1	4	5,5	6,5	-	C6	2	4	18	B	0	2C	(T IIIs)b/(L IIz)b/(T IIIs?)	pl.2
116	70.625	1	5	4,6	6,7	6,0	C7	2	3+4	-	B	1?	2	(T IIIs)b/(T IIz)	pl.12
117	70.605-5	1	4	4,9	6,3	-	C6	1	1	17	A	0?	-	Atypique, voir planche.	pl.10
118	70.700-10	1	4	3,4	6,2	-	C7	2	3+4+1	-	A	0	-	IIIt U.	pl.11
119	70.602-3	1	4	3,8	7,2	-	C8	1-2	4	-	-	?	-	IIIt	pl.12
120	70.688	1	4	4,0	6,2	-	C7	2	4+3?	-	-	0	-	IIIt b/(T IIz)?	pl.12
121	70.554-3	1	4	6,0	6,0	7,0	C7	1	4+3	-	-	0	-	IIz	pl.10
122	70.670-5	1	4	4,2	4,9	-	C7	1	4	-	E	0	2	(T IIIs) b/(T IIz)	pl.12
123	70.?-46	1	4	2,6	4,6	-	C7	1	1	-	E	-	0	-	pl.12
124	70.668-10	1	4	4,5	4,3	-	C7	1	4+1	8	E	?	-	Atypique, voir planche.	pl.10
125	70.?-49	1	4	3,6	5,2	-	C7	1	4	12	A	0	-	IIIs	pl.10
127	70.591-6	1	4	3,8	4,1	-	C7	1	4	-	E	-	0	-	pl.11
130	70.655-1	1	5	5,8	7,0	6,3	C8	2	4+1	14	A	1	2	(T IIIs)b/(T III)b/(II2t)+VIII.	pl.4
	70.655-2	"	"	"	"	"	"	"	"	"	"	"	"	"	"
131	70.664-1	1	4	5,0	6,2	-	C7	1	4+3	13	C	0	2	[(T IIIs)VcIIz]b/(T IIz)	pl.12
132	70.679-50	1	5	3,0	3,4	5,5	C6	1	3+1	14	A	0	-	-	pl.12
133	70.572	1	3	-	-	5,0	C7	2	4+1	-	-	0	-	IIz /b IIIs.	pl.12

1	2	3	4	5	6	7	8	9	10	11	12	13	14	15	16
134	70.679	1	4	7,0	7,9	-	C1	2	1	14	H	0	-	-	pl.12
135	70.608-2	1	3	-	-	7,5	C1	1	1	-	-	-	-	IIf/b II t	pl.12
136	70.634-1	1	3	-	-	5,0	C1	1	1	-	-	-	-	Impressions de filet?Feston à la roulette	pl.12
137	70.534-1	1	3	-	-	5,5	C1	1	1	-	-	-	-	IIs et IIz /b II t	pl.12
138	70.679-7	0	3	-	-	8,0	C7	2	4	-	-	1	2	II3t /b(IIs)	-
	70.679-20	"	"	-	-	"	"	"	"	-	-	"	"	"	-
139	70.667-2	0	3	-	-	6,4	C7	1	4+3?	-	-	1	3	II3t /b(C)	-
140	70.667-4	0	3	-	-	6,8	C7	1	4+3	-	-	1	2?	II5t /b(IIz)	-
141	70.581-2	0	3	-	-	6,4	C7	2	4	-	-	1	?	II2t minimum	-
142	70.691-22	0	3	-	-	5,3	C7	2	4	-	-	1	?	II3t minimum	-
143	70.597	0	3	-	-	7,0	C7	1	4+3?	-	-	1	4?	II5t minimum b(IIf)	-
144	70.673-4	0	3	-	-	6,2	C8	1	4	-	-	0	2?	IIs	-
145	70.677	0	6	-	8,7	7,6	C5	2	6	-	-	1	4	II4t b(IIIz b II4t)	-
146	70.537-4	0	3	-	-	7,0	C8	2	4	-	-	-	0	-	-
147	70.613	1	3	-	-	4,6	C8	2	4	-	-	?	-	Voir planche.	pl.10
148	70.520-2	0	3	-	-	6,2	C7	2	4+3	-	-	-	0	-	-
149	70.523	0	2	-	8,0	-	C7	1	4+3	-	-	?	2D	-	-
150	70.631-1	1	3	-	-	6,4	C8	1	4+3	-	-	1	3?	II3t /b C	pl.9
151	70.604-1	1	3	-	-	6,3	C8	1	4	-	-	1	2	II3t /b(T IIz)/b(T IIs)]	pl.9
152	70.626-1	1	3	-	-	5,5	C8	1	4+3	-	-	0	3	IIf b C	pl.9
153	70.672	1	3	-	-	6,5	C7	2	3+4	-	-	?	3?	IIf b C	pl.9
154	70.649-100	0	3	-	-	6,3	C7	2	4+3	-	-	?	3?	IIf b V	-
155	70.618-2	0	3	-	-	5,0	C8	2	4	-	-	1	4?	IIf /b V	-

1	2	3	4	5	6	7	8	9	10	11	12	13	14	15	16
156	70.638-2	1	3	-	-	5,5	C8	1	4	-	-	?	2	(T II _s)/b/(T III x)	pl.10
157	70.536	0	3	-	-	5,7	C7	2	4+3	-	-	-	0	-	-
158	70.708-1	0	3	-	-	7,0	C7	1	4+3	-	-	1	4	(II3t)/b (V)/b(II3t)/b(V) .	-
159	70.605-8	0	3	-	-	5,3	C8	1	4	-	-	0	2	(T II _z)/b/(T II _s)	-
160	70.656	0	3	-	-	6,6	C8	1	4	-	-	?	4?	(II _t)/b V	-
161	70.619	0	6	-	4,7	4,8	C8	1	4+3	-	-	1	2D	(II5t min.)/b [(T II _s)/b(R II _z)] .	-
162	70.695-2	1	3	-	-	5,6	C8	1	4	-	-	0	?	II _f x II _s x II _z	pl.9
	70.695-3	"	"	-	-	"	"	"	"	-	-	"	"	"	"
163	70.614-7	1	3	-	-	6,3	C8	1	1	-	-	?	?	Voir dessin.	pl.10
164	70.557-12	0	3	-	-	6,8	C8	1	3+1	-	-	-	-	Id.que 163.	-
165	70.549-1	0	3	-	-	5,4	C8	1	4	-	-	-	-	-	-
166	70.679-6	0	3	-	-	7,7	C8	2	4	-	-	1	2	(II3t)/b(T II _s)	-
167	70.617	1	3	-	-	7,3	C8	1	4	-	-	0	3?	(II _f)b V	pl.9
168	70.508-23	1	3	-	-	6,0	C7	1	4+3	-	-	0	?	Voir planche.	pl.10
169	70.679-1	0	3	-	-	7,0	C8	1	4	-	-	1	2	(II3t)/b (T II _s)/b(L II _z)/b(L II _s) +(IIIL).-	-
170	70.679-?	1	3	-	-	6,5	C8	1	4	-	-	1	2	Id.que 169.	pl.9
171	70.679-?	0	3	-	-	5,7	C7	1	4+3	-	-	1	4	(II7t)/b (T II _z et s)/b(II3t)/b(V) .	-
172	70.657-2	1	3	-	-	5,7	C8	1	4	-	-	1	4?	(II3t)/b(V).	pl.4
173	70.651-100	1	3	-	-	7,0	C8	1	4+3	-	-	1	4	(II4t)/b V /b(II4t)/b(T II _z et s) .	pl.9
	70.679-6	"	"	-	-	"	"	"	"	-	-	"	"	"	"
174	70.594-6	1	3	-	-	6,9	C8	1	4	-	-	?	?	Voir dessin.	pl.9
175	70.700-16	0	3	-	-	8	C8	1	4+3	-	-	?	2	(T II _s)/b(L II _z)	-
176	70.691-8	0	3	-	-	8,6	C7	1	4+3	-	-	1	2	(T II _z)/b(T II _s) +II _{ft} dans T II _s .	-
177	70.679-18	0	3	-	-	7,8	C8	1	4+3	-	-	1	?	(II ["] t)/b ?	-

1	2	3	4	5	6	7	8	9	10	11	12	13	14	15	16
178	70.602-7	0	3	-	-	7,4	C7	1	3	-	-	?	2	$[(L\ IIz)/b(T\ IIs)]$.	-
179	70.537-3	0	3	-	-	6,0	C8	1	4	-	-	0	2	$[(T\ IIs)/b(L\ IIz)/b(R\ IIz)]$.	-
180	70.698-3	0	3	-	-	6,9	C8	1	4	-	-	?	2	$[(T\ IIs)/b(T\ IIz\ ft\ \grave{a}\ IIs)]$	-
181	70.644	0	6	-	6,2	4,4	C7	2	4	-	-	1	2	$(II2t)/b[(T\ III)/b(T\ IIs)]$.	-
182	70.679-4	0	3	-	-	4,3	C7	2	3+4	-	-	1	?	$(II6t)/b\ ?$	-
183	70.670-3	0	2	-	5,0	-	C8	1	4	-	-	?	2	$(T\ IIs)/b(R\ IIz)/b(T\ IIs)$.	-
184	70.657-1	0	2	-	6,4	-	C8	1	4+3?	-	-	1	2	$(IIt)b/(T\ IIs)b/(LIIz)$	-
185	70.537-2	0	2	-	6,2	-	C7	2	4	-	-	1	2	$[(IIt)/b(T\ IIz)/b(RII\ ft\ s)/b(T\ IIs)]$.	-
186	70.679-10	0	3	-	-	7,6	C8	1	4	-	-	1	2	$(II\ 3t)/b[(T\ IIs)/b(T\ ou\ L\ IIz)]$.	-
187	70.557-9	0	2?	-	6,3	-	C8	1	4	-	-	1	4	$(II3t)/b[(T\ IIs\ et\ z\ +V)]$.	-
188	70.679-15	0	2?	-	6	-	C8	2	4+3	-	-	?	2	$L\ III + L\ ou\ T\ IIs$.	-
189	70.679-8	0	3	-	-	7,0	C8	1	4+3	-	-	?	2	$T\ IIs\ b/\ R\ IIz$	-
190	70.630-?	0	3	-	-	8,0	C7	2	4+3	-	-	?	?	$?.Surface\ d\acute{e}grad\acute{e}e$.	-
191	70.625-9	0	3	-	-	6,8	C7	2	3+1	-	-	1	2	$(II\ 3t)/b(T\ IIz)$.	-
192	70.681-2	0	3	-	-	6,0	C8	2	4	-	-	0	2?	$T\ IIs?$	-
193	70.554-40	0	3	-	-	6,3	C8	2	4+3	-	-	0	?	$IIt\ b\ IIs$	-
194	70.597-5	0	3	-	-	6,5	C8	1	4	-	-	1	?	$II5t\ /b\ II\ f$	-
195	70.691-5	0	2	-	5,7	-	C8	2	3?	-	-	-	2	$T\ IIs\ /b\ T\ III$	-
196	70.710-15	0	3	-	-	5,7	C7	2	4	-	-	0	-	$II\ f$	-
197	70.605-3	0	3	-	-	6,4	C8	1	4	-	-	0	2?	$T\ IIz$	-
198	70.710-4	0	3	-	-	5,6	C8	2	4	-	-	-	2?	$T\ IIz\ /b\ T\ IIs$	-
199	70.557-22	0	3	-	-	5,4	C7	2	1	-	-	-	3?	$Rz + II\ ft$	-
200	70.548-2	0	2	-	6,3	-	C8	1	4	-	-	0	2	$T\ IIz\ b/\ R\ IIs$	-

1	2	3	4	5	6	7	8	9	10	11	12	13	14	15	16
201	70.691-17	0	3	-	-	7,6	C8	1	4+3	-	-	1	-	II 6t	-
202	70.554-4	0	3	-	-	6,7	C8	2	4+3	-	-	1	-	II 5t	-
203	70.591-2	0	3	-	-	7,2	C8	1	4+3	-	-	0	3?	II t b II f	-
204	70.700-17	0	2	-	7,6	-	C8	2	4+3+1	-	-	0	2	T II s b/ L III b/ T II z	-
205	70.561	0	3	-	-	6,0	C5	2	4	-	-	1	?	II 5t /b C	-
206	70.700-11	0	3	-	-	6,0	C8	2	4+3	-	-	1	4	II 4t /b V /b II t	-
207	70.663-6	0	3	-	-	7,0	C8	1	4?	-	-	-	5	(II z ou s)x(II 2s ou z)	-
208	70.631-2	0	3	-	-	7,2	C8	1	4	-	-	-	-	II f	-
209	70.605-4	0	3	-	-	4,8	C8	1	4	-	-	1	2?	II 3t min. /b(T? II z)	-
210	70.602-13	1	3?	-	-	4,6	C8	1	4	-	-	-	-	Voir planche	pl.10
211	70.679-5	0	3	-	-	6,0	C8	1	4+3	-	-	0	2?	II s	-
212	70.597-10	0	3	-	-	7,0	C6	2	3	-	-	0	2	T II s /b L II z	-
213	70.691-41	0	3	-	-	4,2	C8	1	4	-	-	1	-	II 3min.t	-
214	70.700	0	3	-	-	7,2	C8	1	3+1	-	-	0	3?	Divers cadres secondaires imprimés et incisés	-
215	70.668-1	0	3	-	-	6,2	C8	1	4	-	-	0	-	II s	-
216	70.710-14	0	3	-	-	5,5	C7	1	4	-	-	-	2?	T II s b/(R II z)b/ L vierge.	-
217	70.710-16	0	3	-	-	6,6	C8	1	4	-	-	0	3	II f b(T II s)et(T II z)	-
218	70.597-4	0	3	-	-	6,5	C8	1	4	-	-	-	0	-	-
219	70.557-5	0	3	-	-	7,1	C8	1	4+1	-	-	1	-	II 3t min.	-
220	70.617	0	3	-	-	5,0	C8	1	4	-	-	-	3?	V /b II 4t /b . et II f	-
221	70.602-5	0	3	-	-	7,2	C8	1	4	-	-	-	-	II f?	-
222	70.554-7	0	2	-	3,4	-	C8	1	4+3	-	-	0	2	T II s b/T II z	-

1	2	3	4	5	6	7	8	9	10	11	12	13	14	15	16
224	70.668-14	0	2	-	5	-	C7	2	3+4	-	-	1	2?	II4t b/T IIs	-
	70.668-16	"	"	-	"	-	"	"	"	-	-	"	"	"	-
223	70.668-6	0	3	-	-	5,7	C8	1	4	-	-	1	4?	II6t /b II f /b II t	-
225	70.710-13	0	2	-	6	-	C7	1	4	-	-	1	2	II3t min. b/ T IIs b/ T IIz	-
226	70.668-7	0	2	-	5,7	-	C8	1	4+3	-	-	1	2	II4 T min. b/ T IIs b/ T IIz	-
227	70.708-24	0	3	-	-	4?5	C8	1	4+3+1	-	-	0	2	T IIz /b L IIs	-
									+coquille						
228	70.696-1	0	3	-	-	8	C8	1	4	-	-	-	2?	IIs ou z	-
229	70.679-17	0	3	-	-	7,4	C8	1	4+3	-	-	-	2?	L IIz b/ T? IIs	-
230	70.641-74	0	3	-	-	4,8	C8	1	4	-	-	-	3?	voir planche, n°153 pl.9	-
231	70.647-97	1	11	-	-	7	C7	1	4	-	-	-	-	-	pl.11
232	70.636-74	1	11	-	-	4,6	C5	2	1	-	-	-	-	-	pl.11
233	70.625-8	1	11	-	-	3,4	C7	2	4	-	-	-	-	-	pl.11
234	70.616	1	11	-	-	7	C7	2	4	-	-	-	-	-	pl.11
235	70.640	1	3	-	-	5	C8	1	4+1	-	-	?	2	voir planche.	pl.11

MANTSETSI :

236	72.718-9	0	1	9,4	-	-	C7	2	3+1(2).	-	H	-	?	type Kay Radio	-
237	72.718-3	0	3	-	-	8,6	C7	1	3+1?	-	-	-	1	VIIIs>>/b VIIIt	-
238	72.735	0	3	-	-	7,4	C6	2	3+1	-	-	-	1	VIIIs x VIIz	-
239	72.734	0	3	-	-	8,5	C7	1	3+1	-	-	-	1	VIIIs>>/b VIIIt	-
240	72.736	0	3	-	-	9	C8	1	3+2	-	-	-	1	VIIIs>>/b VII5t	-
241	72.727	0	3	-	-	8,7	C7	1	3+1	-	-	-	1	VIIz	-
242	72.733	0	3	-	-	6,8	C7	2	3+1	-	-	-	1	VIIz	-

1	2	3	4	5	6	7	8	9	10	11	12	13	14	15	16
243	72.726-12	0	1	8	-	-	C7	2	3+1	min. A	-	1	VIIIf x VIIIt	-	
										14					
244	72.764-30	0	1	9,5	-	-	C7	1	3	-	I	-	1	VIIIs	-
245	73.007	0	1	9	-	-	C7	2	3+1	-	A	-	1	VIIIt /b VIIz	-
246	73.005	0	3	-	-	9,8	C7	1	3+1	-	-	-	1	VIIIs>> b/ VIIIt	-
247	73.030	0	1	9,2	-	-	C7	2	3+1	min. A	-	1	VIIIt b/ VIIz	-	
										19					
248	73.098	0	1	5,9	-	-	C7	2	3+1	-	A	-	1	?	-
249	73.051-3	0	1	8,4	-	-	C7	1	3+1	-	A	-	1	VIIIt b/ VIIz x VIIIs	-
250	73.051-2	0	1	7,8	-	-	C7	1	3+1	21	A	-	1	?	-
	73.051-1	"	"	"	-	-	"	"	"	"	-	"	"		-
251	72.761	1	3	-	-	7,5	C8	1	3+1	-	-	-	1	VIIIt /b VIIIs /b VIIz	pl.18
252	72.898	1	3	-	-	9,7	C8	1	3+1+4?	-	-	-	1	VIIIs>>/b VIIz>>	pl.18
253	73.014	1	6	-	7,9	9,5	C8	1	1	-	-	-	1	VIIz /b IV b/ VIIz x VIIIs	pl.18
254	72.899	1	6	-	8,2	8,2	C7	2	3	-	-	-	1	Voir dessin	pl.18
255	72.938-3	1	2	-	7,9	-	C7	2	3+1	-	-	-	1	VIIz x VIIIs /b IV	pl.18
256	72.759	1	6	-	5,2	7,3	C6	2	3	-	-	-	1	VIIz x VIIIs VIIIt x feston	pl.18
257	72.752	1	3	-	-	8,5	C7	1	3	-	-	-	1	IIz	pl.18
258	72.917-1	1	3	-	-	9,6	C7	2	3	-	-	-	1	Voir dessin	pl.18
259	72.904	0	3	-	-	9,9	C7	1	3	-	-	-	1	IIIt>> x VIIIf	-
260	72.264-3	1	11	-	-	13	C7	2	3	-	-	-	-	} Jointifs?Ep.du fond=17 à 18 mm.	pl.19
261	72.764-1	0	11	-	-	13	C7	2	3	-	-	-	-		
262	72.760	0	1	10	10,5	-	C7	1	1	?	A	-	-	-	-
	72.764														

1	2	3	4	5	6	7	8	9	10	11	12	13	14	15	16
263	72.738	0	1	8,8	-	-	C7	2	3+1	17	I	-	1	VIIIt x VIIIf x VIIz	-
264	72.731	1	4	8	7,9	-	C7	2	3+1+4?	21	I	-	1	VIIIf x VIIIt x VIIz	pl.17
265	72.728	1	4	8,2	8,1	-	C7	2	3+1	20	I	-	1	VIIIf x VIIIt x VIIz	pl.17
266	72.763	1	4	10,2	9,2	-	C7	2	3+1	27	H	-	1	(II 4 t)b/(VIIz x VIIIs)	pl.16
267	72.757	1	4	8,4	10	-	C7	1	3	15	H	-	1	VIIz x VIIIs	pl.16
268	72.906	1	4	9	9,7	-	C7	2	3	28-31A	-	-	1	(II3t)b/(IIIf x IIz)	pl.16
269	73.010	1	4	8,5	9,9	-	C8	1	3+1	29	I	-	1	(VII 3t)b/ VIIz	pl.16
270	72.719	1	4	10	10	-	C6	1	3	-	A	-	1	(VII 3t)b/(IIz x IIIs)	pl.17
271	72.710	1	4	13,8	8,8	-	C6	1	3	-	C	-	1	(VII 2t)b/ VIIz	pl.17
272	72.601	1	4	5,4	7,2	-	C8	1	1	-	A	-	0	Peut-être Kanda Kumbi.Voir texte.	pl.17
273	72.933	1	4	5,5	6,3	-	C8	1	3	15	H	-	1	(II 2t)b/ chevrons incisés /b IIIt	pl.17
274	72.753	1	4?	4,4	6,0	-	C8	1	1	14	A	-	1	(IIIt)b/ IIz x IIIs	pl.17
275	72.764	1	1	5,9	-	-	C8	1	1	-	A	-	1	II» z x II» s	pl.17
276	72.764-25	1	1	6	-	-	C8	1	1	-	I	-	1	II3t x II» f	pl.17
277	72.930	0	1	7,2	-	-	C6	2	3	+25	A	-	1	(VII2t)b/(VIIz x VIIIs)	-
278	72.938	0	1	8,5	-	-	C7	2	3+1	18	A	-	1	(VII2t)b/(VIIz x VIIIs)	-
279	72.906	0	1	9	-	-	C7	2	3+1	21	I	-	1	(VII2t)b/ VIIz	-
280	72.007-1	0	1	10	-	-	C7	2	3+1	-	A	-	-	-	-
281	72.596	0	4	9	7,9	-	C7	1	3+1	-	A	-	-	-	-
282	72.935-4	0	1	8,9	-	-	C8	1	3+1	21	H	-	1	(VII2t)b/ VIIz	-
283	72.696-5	0	1	11,3	-	-	C7	1	3+1	+26	A	-	-	-	-
284	73.040	0	1	6,8	7,3	-	C8	1	3	17	A	-	-	-	-

1	2	3	4	5	6	7	8	9	11	10	12	13	14	15	16
285	73.041	0	1	6,6	-	-	C6	1	3+1	19	A	-	-	-	-
286	73.010-4	0	1	9	-	-	C6	2	3	-	H	-	-	-	-
287	72.764-8	0	4	8,2	8	-	C7	2	3+1	-	A	-	-	-	-
288	72.750	0	1	7	-	-	C8	2	1	20	A	-	1	-	-
289	72.732	0	1	8,6	-	-	C7	2	3+1	-	I	-	-	-	-
290	72.726-14	0	3	-	-	8	C7	1	4+3	-	-	-	1	VIIz	-
291	72.755	0	3	-	-	7,4	C8	1	4+1	-	-	-	1	VIIz	-
292	72.726	1	6	-	5,2	6,4	C8	1	4	-	-	-	1	Voir planche.	pl.15
	72.730	"	"	-	"	"	"	"	"	-	-	-	"	"	"
293	73.010	1	3	-	-	6,6	C8	1	4	-	-	-	1	IIIt b/tissu (?)imprimé.	pl.15
294	73.015	1	3	-	-	8,3	C8	1	4	-	-	-	1	VII>>curvilignes	pl.15
295	72.762	1	3	-	-	10,7	C3	1	1	-	-	-	1	II>>f x II>>t /bII 3t	pl.15
296	72.756	1	3	-	-	7	C8	1	4?	-	-	-	1	Roulette quadrangulaire imprimée.	pl.15
297	72.892	1	3	-	-	4,1	C8	1	4+3	-	-	-	1	IV triangulaire sur deux rangs.	pl.15
298	72.887	1	3	-	-	10,6	C7	2	4?	-	-	-	1	IIIt b/ IIIf x IIIt	pl.15
299	72.754	1	3	-	-	7,5	C8	1	1	-	-	-	1	Voir dessin.	pl.15
300	72.895	1	3	-	-	8,3	C8	1	1	-	-	-	1	Deux types de roulette imprimés.	pl.15
301	72.904	1	3	-	-	5,8	C6	2	3+1	-	-	-	1	IIIs x IIz	pl.15
302	72890	1	3	-	-	6,5	C3	2	3+1	-	-	-	1	Chevrons incisés.	pl.15
303	81.097	1	1	5	-	-	C6	2	3+1	-	-	-	1	Id.que 302.	pl.18
304	72.625	1	11	-	-	-	C6	2	1	-	-	-	0	Ep.du fond + 4,5.	pl.18
305	73.045	1	5	4	7,6	8,4	C3	1	6	20	A	-	1	IIIt b/ IIIt x IIz /b IIIt	pl.19

1	2	3	4	5	6	7	8	9	10	11	12	13	14	15	16
<u>KINKENGE:</u>															
306	73.104	1	4	11,5	11	-	C8	1	3+1	23	H	-	1	(VII>> t)b/(VII s x VIIz)	pl.19
<u>KINDU II:</u>															
307	72.518	1	4	9,8	10	-	C6	2	3+1	-	A	-	1	(VII3t)b/ VIIIf x chevrons VII+IV	pl.20
308	72.578	0	4	5,9	7,3	6,3	C7	2	3+2	16	H	-	1	[(VII3t)b/(VIIz x VIIIs)] [VIIz]	-
309	72.502	1	4	7,2	9,4	-	C8	1	3+1	19	H	-	1	VIIIt>> x VII3z.	pl.20
310	72.502-2	0	4	7,8	7,8	-	C8	1	3+2	15	H	-	1	VII3t b/ VIIz x VIIIs	-
311	72.501	0	2	-	10	-	C7	2	3+2	-	-	-	1	VII>> f x VIIz	-
312	72.501-1	1	4	10,5	9,3	-	C7	2	3+1	+40	A	-	1	(VII4t)b/VIIIf>>.	pl.21
313	72.476	1	4	8,4	11,1	-	C7	2	3+1+2?	36	A	-	1	(VII2t)b/ [(T VIIz)b/(T VIIIs)].	pl.21
314	72.901	1	5	6,6	7,8	7,9	C8	1	3+2	+16	H	-	1	(VII3t)b/ (VIIz x VIIIs)/b VIIIt b/(T VIIz) et (T VIIIs) /b VIIIt.	pl.20
315	72.513	1	4	9,3	9,7	-	C7	1	3+1	-	I	-	1	Voir dessin.	pl.21
316	72.476-4	1	4	9,2	6,9	-	C8	1	3+6	27	I	-	1	(T VIIz) et (T VIIIs) /b VIIIt b/ (T VIIIs) et (T VIIz) .	pl.21
317	72.503	0	4	10,7	7,9	-	C7	2	3+1	+16	A	-	1	(VII3t)b/(VIIIf>>).	-
318	72.501-7	1	6	-	9	7,6	C7	1	1	-	-	-	1	(VIIz)/b VIIIt b/(VIIIs)x(VIIz)	pl.20
319	72.502	0	3	-	-	10,7	C7	2	3+2+1	-	-	-	1	VIIz>>x VIIIs;dégraissant 2=4mm.	-
320	72.501-11	0	3	-	-	8	C8	1	3	-	-	-	1	VIIIt>> x VII3s	-
321	72.513-3	0	3	-	-	7,8	C7	2	3+2	-	-	-	1	VII>> .	-
322	72.470	1	4	7,2	8	9	C7	2	3+1	20	H	-	1	IIIt /b IV b/ IIIt.	pl.20
323	72.500-5	1	4	7,7	7,4	-	C7	2	3+1	-	I	-	1	VIIIf x VIIz -IV1.	pl.20
324	72.503-6	0	3	-	-	10	C7	2	3+1	-	-	-	1	VIIz .	-

1	2	3	4	5	6	7	8	9	10	11	12	13	14	15	16
325	72.513	0	4	9,5	9,2	-	C7	2	3+1	?	H	-	1	VIIIt	-
326	72.518	0	3	-	-	8,8	C7	2	3+1	-	-	-	1	VIIIt b/ VIIIs	-
327	72.503	0	3	-	-	7	C8	1	3	-	-	-	1	VIIIt	-
328	72.476	0	3	-	-	6,8	C7	1	3	-	-	-	1	VIIz x VIIIs	-
329	72.476	0	3	-	-	6,6	C7	2	1	-	-	-	1	IV 1.	-
330	72.503	0	3	-	-	8,9	C7	1	3+2?	-	-	-	1	VIIft	-
331	72.503	0	3	-	-	9	C7	1	3+1	-	-	-	1	VIIft	-
332	72.503	0	3	-	-	8,8	C7	2	3+1	-	-	-	1	VIIIt b/ VIIz	-
333	72.579	0	4	7	6,5	-	C8	1	1	-	A	-	1	VII 4t b/ VIIz	-
334	72.518	0	4	7,4	8,4	-	C7	1	3+2	16	H	-	1	VIIz>> b/ VIIIs>>.	-
335	72.476	0	4	9,6	10,2	-	C7	1	3+1	-	E	-	1	VII3t b/ VIIz	-
336	72.476	0	4	8	8,4	-	C7	2	3+1	-	E	-	1	;VII2t b/ VIIz	-
337	72.85?-?	0	4	6,4	-	-	C7	1	3+2?	-	H	-	1	VIIIt b/ VIIz	-
338	72.513	0	4	9	-	-	C7	1	3+2	-	I	-	1	VIIIt	-
339	72.501	0	4	10,6	10,2	-	C7	2	3+1	+25	A	-	1	(VII4t)b/(VII>>f x VIIz).	-
340	72.476	0	4	10	9,4	-	C7	1	3+1	-	A	-	-	-	-
341	72.476	0	4	7,5	7,8	-	C8	2	3+1	-	A	-	-	-	-
342	72.505	0	3	-	-	9,9	C8	2	3	-	-	-	1	VIIft	-
343	72.476	0	4	6,9	7,5	-	C7	2	1	-	-	-	-	-	-
344	72.569	0	3	-	-	8,5	C7	2	3	-	-	-	1	VIIIt /b VIIIs	-
345	72.501	1	10	-	-	-	C7	2	3+1	-	-	-	-	-;ép.fond=14 mm.	pl.21
346	72.476	1	10	-	-	-	C7	2	3+6	-	-	-	-	-;ép.fond=18,5 mm.	pl.21

1	2	3	4	5	6	7	8	9	10	11	12	13	14	15	16
347	72.528	0	4	6	6,5	-	C7	1	1	-	A	-	-	-	-
348	72.533	0	4	6,5	10,4	-	C7	2	1	-	H	-	-	-	-
349	72.496	1	3	-	-	5	C7	2	4?	-	-	-	1	IIz x IIs	pl.22
350	72.476	0	3	-	-	6	C7	1	4?	-	-	-	1	Roulette végétale imprimée?	-
351	72.501	0	3	-	-	7,2	C8	1	4	-	-	-	1	Id.	-
352	72.501-87	1	4	4,2	7,3	-	C8	1	4	18	A	-	1	VIIIt b/ IV I. b/ IIz x IIs	pl.22
353	72.518	1	5	5,2	5,3	5,3	C8	1	4+1	min.14	A	-	1	Voir dessin.Roulettes?+ IIt et f.	pl.22
										max.20					

SUMBI:

354	72.445	1	5	4	5,7	7,3	C7	1	2+5	20	A	-	1	Icisions,"écaillés"et impressions au peigne.	pl.23
355	72.444	1	5	3,4	5,7	7,9	C7	1	2+3+5	20	A	-	1	Id. que 354.	pl.23
356	72.444-8	0	3	-	-	6,4	C7	1	2+5	-	-	-	1	Id.que 354.	-
357	72.444-2	0	3	-	-	7	C7	1	2+5	-	-	-	1	Id. que 354.	-
358	72.444-7	0	3	-	-	6,7	C7	1	2+5	-	-	-	1	Id. que 354.	-
359	72.444-5	0	3	-	-	8	C7	1	2+5	-	-	-	1	Id. que 354.	-
360	72.444-9	0	3	-	-	7	C7	1	2+5	-	-	-	1	Id. que 354.	-
361	72.446	1	5	2,1	4,7	5,5	C7	1	2+5	7	A	-	1	Id. que 354	pl.23
362	72.448-4	1	5	3	5	5,7	C7	1	1	13	A	-	1	Id. que 354.	pl.23
363	72.448-2	1	5	3,8	5	6,8	C7	1	2+5	16	A	-	1	Id. que 354	pl.23
364	72.448-3	1	5	4,7	5,4	6,4	C7	1	1	-	A	-	1	Id. que 354.	pl.23

1	2	3	4	5	6	7	8	9	10	11	12	13	14	15	16
365	72.454	1	3	-	-	7,9	C6	1	3+1	-	-	-	1	Id. que 354.	pl.24
366	72.447	1	6	-	6,5	7,3	C7	1	2+5	-	-	-	1	Id. que 354 +peigne imprimé croisé.	pl.24
367	72.001	1	6	-	7	6,5	C7	1	5+2+1	-	-	-	1	III x,IIt,IIf,III en chevrons.	pl.24
368	72.452	1	3	-	-	7	C8	1	2+5	-	-	-	1	IIt,III en chevrons ft.	pl.24
369	72.444-3	0	6	-	6	6,5	C7	1	2+5	-	-	-	1	Id. que 354.	-
370	72.448-5	0	4	4,7	6,4	6	C7	1	2+5	-	-	-	1	Id. que 354.	-
371	72.448-1	0	5	3,5	5,4	6,2	C7	1	2+5	-	-	-	1	Id. que 354.	-
372	72.302	1	3	-	-	5,4	C7	1	2+5+3?	-	-	1	2	(II2t)/b [(II2z x II2s) b (III)]	pl.24
373	72.022	0	3	-	-	4,4	C6	2	3+1	-	-	0	1	IIIx	-
374	71.981	1	3	-	-	5,5	C7	2	2+3	-	-	-	5	II2s x II>> z.	pl.24
375	72.008	0	3	-	-	6,7	C7	1	2+6	-	-	-	1	Molette triangulaire imprimé sur un rang, /b II.	-
376	72.283	1	3	-	-	6,7	C6	1	6+3?	-	-	-	1	Vb	pl.26
377	72.001	1	3	-	-	6,5	C7	1	2+3?	-	-	-	1	VII /b III	pl.26
378	71.975	1	6	-	6,6	7	C6	1	3+6+5	-	-	-	1	(T I?z)b/(T I?s).	pl.25
379	72.459	1	6	-	6,3	6	C6	1	6	-	-	-	1	(II2t)b/[(R II f)(R II ft)et IIIx] .	pl.25
	72.290	"	"	-	"	"	"	"	"	-	-	-	"	"	"
	72.022	"	"	-	"	"	"	"	"	-	-	-	"	"	"
380	72.006	1	6	-	6,9	7	C6	1	6	-	-	-	1	Voir planche.	pl.24
	72.983	"	"	-	"	"	"	"	"	-	-	-	"	"	"
	72.474	"	"	-	"	"	"	"	"	-	-	-	"	"	"
	72.473	"	"	-	"	"	"	"	"	-	-	-	"	"	"

1	2	3	4	5	6	7	8	9	10	11	12	13	14	15	16
380	71.983	1	6	-	6,9	7	C6	1	6	-	-	-	1	Voir planche	pl.24
	72.280	"	"	-	"	"	"	"	"	-	-	-	"	"	"
	72.022	"	"	-	"	"	"	"	"	-	-	-	"	"	"
381	72.473	1	3	-	-	5,8	C6	1	1	-	-	-	1	Voir planche.	pl.24
382	72.473-2	1	5	7	9	9	C6	2	3+1	15	F	-	1	IIz x IIs	pl.25
383	72.473	1	6	-	5	6	C6	1	1	-	-	-	1	IIz x IIs	pl.25
	72.465	"	"	-	"	"	"	"	"	-	-	-	"	"	"
384	72.313	1	3	-	-	6,4	C4	2	1	-	-	-	1	Voir planche.	pl.26
385	72.364	0	3	-	-	8,5	C6	1	1	-	-	-	1	Filet imprimé.	-
386	72.022	0	6	-	7,3	7,3	C7	1	3+5	-	-	-	1	Id. que 378.	-
387	71.983	0	3	-	-	7	C7	1	4+3	-	-	-	1	Trainé.	-
388	71.994	1	3	-	-	6,2	C7	1	4+3	-	-	-	1	"	pl.26
389	72.304	0	3	-	-	8	C7	1	4+3	-	-	-	1	"	-
390	71.999	1	4	4	6	7	C6	2	4+3	-	H	-	1	IIz x IIs	pl.25
	72.014	"	"	"	"	-	"	"	"	-	"	-	"	"	"
391	72.325	1	3	-	-	8	C8	1	4+3+5	-	-	-	1	Voir planche.	pl.26
392	72.018	0	3	-	-	6	C8	1	4	-	-	-	1	Filet imprimé.	-
393	72.296	0	1	8,3	-	-	C8	2	4+1	-	H	-	1	Tracé t.	-
394	72.001	0	3	-	-	7	C8	1	4	-	-	-	1	Tracé	-
395	72.313	0	4	8,6	9,7	-	C8	1	1	-	-	-	1	Tracé t.	-
396	72.018	0	4	4,6	7	-	C7	1	3	-	-	-	-	-	-
397	72.323	1	5	4,7	8	7,6	C7	1	6+1	24	A	-	-	-	pl.42
398	72.294	0	4	3,4	7,8	-	C7	1	3+6	-	A	-	-	-	-

1	2	3	4	5	6	7	8	9	10	11	12	13	14	15	16
399	72.459	1	4	6,6	8,2	-	C7	1	3+1	27	A	-	-	-	pl.43
400	72.283	1	5	6,2	6,7	5,3	C7	1	3+5	15	F	-	-	-	pl.43
401	72.317	1	4	4	7,7	-	C6	1	2+1	23	A	-	-	-	pl.43
402	72.317	1	4	3,3	4,5	-	C5	1	2+3	11	A	-	-	-	pl.43
403	72.319	1	4	2,5	5,7	-	C6	1	1	12	G	-	-	-	pl.43
404	72.465	1	5	3,2	3,6	5,8	C6	1	1	10	G	-	-	-	pl.42
405	71.981	0	4	3,9	6	-	C5	1	2+6	-	A	-	-	-	-
406	72.336	0	5	3,9	5,3	5,8	C6	1	3+6	-	H	-	-	-	-
407	72.325	0	4	4,4	8,6	-	C7	1	3+1	-	B	-	-	-	-
408	72.022	0	4	4,8	6,6	-	C6	2	1	-	A	-	-	-	-
409	72.299	0	4	4,4	8	-	C7	1	2+3	-	A	-	-	-	-
410	72.319	0	4	2	5,4	-	C7	1	2+3	-	G	-	-	-	-
411	72.018	0	4	5	7	-	C7	1	1	-	H	-	-	-	-
412	72.459	0	4	5,5	8,9	-	C7	1	3	-	H	-	-	-	-
413	72.317	0	4	3,8	6,4	-	C7	1	2+3	-	H	-	-	-	-
414	72.022	0	4	3	6,2	-	C7	1	3	-	H	-	-	-	-
415	72.022	0	3	-	-	8,4	C6	1	1	-	-	-	1	T IIs b/ T IIz.	-
416	72.311	0	3	-	-	7,3	C7	1	3+6	-	-	-	1	IIs x IIz	-
417	72.014	0	3	-	-	8,4	C5	1	3+6	-	-	-	1	IIs x IIz	-
418	71.983	0	3	-	-	7,5	C8?	1	3+6	-	-	-	1	IIIs b/ IIIz	-
419	71.991	0	3	-	-	9,8	C7	1	3+6	-	-	-	1	IIIt	-
420	72.022	0	3	-	-	10,5	C7	1	6+3	-	-	-	1	IIIt x IIz	-

1	2	3	4	5	6	7	8	9	10	11	12	13	14	15	16
421	71.999	0	3	-	-	10,3	C8	1	6+3	-	-	-	1	IIIs x IIz	-
422	72.022	0	3	-	-	9	C6	1	3	-	-	-	1	IIx irrégulières.	-
423	72.301	0	3	-	-	6,7	C7	1	3	-	-	-	1	IIs /b IIt	-
424	71.999	0	3	-	-	9	C8	1	6+3	-	-	-	1	IIIs b/ IIz	-
425	71.988	0	3	-	-	9	C7	1	3+6	-	-	-	1	IIs /b IIt	-
426	71.999	0	3	-	-	8	C8	1	6+3?	-	-	-	1	IIs	-
427	72.473	0	3	-	-	6,9	C7	1	6+3	-	-	-	1	IIIs b/ IIz	-
428	72.308	0	3	-	-	10,2	C7	1	2+3	-	-	-	1	IIIs b/ IIz	-
429	72.299	0	3	-	-	7,5	C7	1	2+6	-	-	-	1	IIs x IIz	-
430	72.469	0	3	-	-	9,6	C7	1	3	-	-	-	1	IIIf x IIs x IIz	-
431	72.383	0	3	-	-	7,4	C6	1	3	-	-	-	1	IIs	-
432	71.983	0	3	-	-	5,5	C6	1	3+5+6	-	-	-	1	IIIs b/ IIz	-
433	72.301	0	3	-	-	8,2	C7	1	3	-	-	-	1	IIIs b/ IIz	-
434	72.001	0	3	-	-	10	C7	1	3	-	-	-	1	IIIt x IIs	-
435	72.325	0	3	-	-	8	C8	1	5+3	-	-	-	1	IIz b/ IIIs	-
436	72.313	0	3	-	-	6,8	C7	1	5+3	-	-	-	1	IIIt /b IIs /b IIz	-
437	72.008	0	3	-	-	8,5	C7	1	3+1	-	-	-	1	IIz x IIs	-
438	71.994	0	3	-	-	6,6	C7	1	3+1	-	-	-	1	IIIt /b IIz	-
439	72.323	0	3	-	-	8,3	C7	1	3+6	-	-	-	1	IIz x IIs	-
440	71.991-4	0	3	-	-	9	C8	1	3+1	-	-	-	1	VIIIt x VIIz	-
441	72.???	0	3	-	-	7,5	C7	1	3+6	-	-	-	1	VIIz x VIIIs /b VIIIt	-
442	71.996	0	2	-	8,3	-	C7	2	3	-	-	-	1	VIIIs	-
443	71.999	0	3	-	-	6,9	C8	1	3+6	-	-	-	1	IIs>>/b IIIt	-

1	2	3	4	5	6	7	8	9	10	11	12	13	14	15	16
444	72.301	0	3	-	-	8	C6	1	3	-	-	-	1	T IIs /b T IIz	-
445	71.993	0	3	-	-	7,5	C7	1	3+6	-	-	-	1	II>>t x IIs	-
446	72.469	0	3	-	-	7,8	C7	1	3+6	-	-	-	1	IIIz /b IIIs	-
447	72.311	0	3	-	-	10,8	C7	1	7+3	-	-	-	1	VIIIt>> x VIIz	-
448	71.983	0	3	-	-	8,4	C7	1	3+6	-	-	-	1	VII>>s /b VIIIt	-
449	72.022	0	3	-	-	8,8	C7	1	3+6	-	-	-	1	VII>>z	-
450	72.022-14	0	3	-	-	10,2	C8	1	3+6	-	-	-	1	VII>>z	-
451	71.994	0	3	-	-	10,8	C7	1	3+6	-	-	-	1	IIz x IIs	-
452	72.022	0	3	-	-	7,7	C6	1	3+4 +5	-	-	-	1	IIIf x IIz /b IIIt	-
453	72.001-60	0	3	-	-	6	C6	1	3+6	-	-	-	1	IIz >> x II _s	-
454	72.473	0	3	-	-	9,7	C7	1	3+6	-	-	-	1	IIIt>> x II>>f x IIz	-
455	72.001-8	0	3	-	-	7,9	C7	1	3+6	-	-	-	1	VIIIs>>	-
456	72.014-1	0	3	-	-	9	C6	1	6	-	-	-	1	IIIs /b IIIz	-
457	72.014-25	0	3	-	-	9,2	C6	1	3+6	-	-	-	1	IIs x IIz	-
458	72.001-20	0	3	-	-	6,7	C8	1	3+6	-	-	-	1	IIs >> /b IIIt	-
459	72.306-15	0	3	-	-	12,4	C7	1	3+6	-	-	-	1	IIIf x IIz	-
460	72.001-36	0	3	-	-	9,3	C7	1	3+6	-	-	-	1	IIIs /b IIIz	-
461	72.311	0	3	-	-	7	C6	1	3+6	-	-	-	1	IIIs /b IIIz	-
462	72.306-12	0	3	-	-	11,4	C7	1	3+6	-	-	-	1	IIs x IIz	-
463	72.001-27	0	3	-	-	9,6	C7	1	3+6	-	-	-	1	IIIt x IIs	-
464	71.988-5	0	3	-	-	6,2	C7	1	3+5 +6	-	-	-	1	II>>z x IIIf /b IIIt	-
465	72.001-5	0	3	-	-	9	C8	1	3+6	-	-	-	1	IIIs /b IIIz	-
466	72.306-6	0	3	-	-	10	C7	1	3+7	-	-	-	1	II>>s	-

1	2	3	4	5	6	7	8	9	10	11	12	13	14	15	16
467	72.022-16	0	3	-	-	7,2	C7	1	3+6	-	-	-	1	II2t b/ II>>s	-
468	72.001-21	0	3	-	-	9,2	C8	1	3+6	-	-	-	1	VIIIt>>.	-
469	72.012-3	0	2	-	7,3	-	C8	1	3+6	-	-	-	1	VIIIt>>.	-
470	72.325-5	0	3	-	-	8,5	C7	2	3+6+5	-	-	-	1	IIIt	-
471	71.991-9	0	3	-	-	8,6	C8	1	3+1	-	-	-	1	II2t b/ IIz	-
472	71.994-9	0	3	-	-	9,6	C8	1	3+1	-	-	-	1	IIz /b IIIt	-
473	72.008-13	0	3	-	-	8,8	C6	1	3+6	-	-	-	1	IIz	-
474	71.983-31	0	3	-	-	8,1	C6	1	1	-	-	-	1	IIIt /b VIIIs>>.	-
475	72.001-47	0	3	-	-	8	C7	1	6+1	-	-	-	1	VIIIt /b VIIIs>>.	-
476	72.014-23	0	3	-	-	9,6	C7	1	3+1	-	-	-	1	VIIz x VIIIt	-
477	71.981-7	0	3	-	-	5,7	C8	1	1	-	-	-	1	IIz x IIs	-
478	71.983-24	0	3	-	-	9,5	C6	1	1	-	-	-	1	IIIs b/ IIIz b/ IIIt	-
479	72.455	0	3	-	-	8,6	C8	1	3+6	-	-	-	1	IIIz b/ IIIs b/ IIIt	-
480	72.308	0	6	-	9,9	10	C7	1	3+7	-	-	-	1	{(IIz)} {(IIs)} .	-
481	71.994-6	0	3	-	-	8	C7	1	3+7+2	-	-	-	1	IIIIf x VIIIt	-
482	72.022-4	0	6	-	5,6	7	C7	1	3+2	-	-	-	1	Indéterminable car érodé.	-
483	72.008	1	5	6,8	8	8,8	C7	1	3+6	19	H	-	1	{(IIz b/ IIs)} x {(IIIt et IIIfestons)}	pl.27
484	72.306-5	1	5	6,5	8,4	8,2	C8	1	3+6	12	H	-	1	(IIIt x IIs et IIz) b/(IIIz)b/(IIIs)	pl.27
485	71.994	1	5	6	6,3	8,2	C8	1	3+6	17	A	-	1	{T VIIz b/ TVIIs} b/[chevron VII] b/[TVIIz b/ TVIIs] /b VIIIt b/[TVIIz b/ TVIIs] .	pl.28
486	72.313	1	4	7	10,1	-	C8	1	3+6	19	A	-	1	VII2t b/ [VIIz b/ TVIIs] /b VIIIt b/[VIIz b/ TVIIs] .	pl.28

1	2	3	4	5	6	7	8	9	10	11	12	13	14	15	16
487	72.301	1	4	6	8,8	-	C8	1	3+6	16	H	-	1	IIIt b/[IIIz b/ VIIIs] /b IIIt	pl.28
488	71.991	1	5	5,9	8,3	7	C8	1	3+7	21	A	-	1	VIIIt b/[VIIz b/ VIIIs] /b VIIIt b/[VIIz	
	71.983	"	"	"	"	"	"	"	"	"	"	-	"	b/ VIIIs] .	pl.28
489	72.001-4	1	4	13,5	14,3	-	C7	1	3	-	A	-	1	VI	pl.26
	72.014-15	"	"	"	"	-	"	"	"	-	"	-	"	"	"
490	73.110	1	5	8,4	6,5	6	C8	1	3+6	24	H	-	1	[VIIIt b/ (VII>>z)(VII>>s)] [VIIIt b/(VII>> s)	
														(VII>> z)] .	pl.29
491	72.325-2	1	5	7,4	7,3	6,1	C7	1	3+1	23	H	-	1	II2t b/[(II>> z x IIs)]. IIIt b/ II>>z)	pl.29
492	71.983	1	5	7	-	9	C7	1	3+7	13	A	-	1	IIIt b/[IIIz b/ IIIs] /b IIIt.	pl.29
	72.001	"	"	"	-	"	"	"	"	"	"	-	"	"	"
493	71.983	0	6	-	8	8	C7	1	3+7	-	-	-	1	[II>>s x IIz3] . [IIIf x II>> z] .	-
494	71.983	0	6	-	7,3	7	C8	1	3+6	-	-	-	1	IIz x IIs . IIIf x IIz.	-
495	71.981-8	0	3	-	-	7,2	C7	1	3+6	-	-	-	1	IIIf x IIz /b II3t	-
496	72.325	0	4	8	7,8	-	C8	1	3+6	-	A	-	1	IIIf x IIz x IIs	-
497	72.325	1	3	-	-	8,2	C7	1	3+1	-	-	-	1	IIIt	pl.37
498	72.311	1	4	7	6	-	C8	1	3+2?	-	H	-	1	VII>> z x VIIs	pl.37
499	72.006	1	5	8	8,6	6,7	C8	1	3+6	-	H	-	1	IIIt/b [VIIIf x VIIIs] . VIIIt b/[(VIIz b/	
														VIIIs)] .	pl.34
500	71.994	1	5	8,1	8	5,6	C7	1	3+6+5?	22	H	-	1	II3t b/[(VIIz x VIIIs)] . VIIIt b/[(VIIz)	
														b/ (VIIIs)] /b VIIIt.	pl.34
501	72.001-1	1	5	8	7,7	7	C7	2	3+6	17	H	-	1	VII2t b/[(VIIIs x VIIz)]; VIIIt b/(VIIz).	pl.33
502	72.469-3	1	4	8,8	9,4	-	C7	1	3+6	16	I	-	1	VII4t b/[(VIIIf x VIIz)] .	pl.33
503	72.313-6	1	4	6,5	6,7	-	C8	1	3+1	14	H	-	1	VII2t b/[(VIIz x VIIIs3)] .	pl.33

1	2	3	4	5	6	7	8	9	10	11	12	13	14	15	16
504	72.298	1	5	6,6	8,4	8,7	C8	1	3+7	16	A	-	1	(VIIIt v IV) b/(VIIz x VIIIs);(VIIIt v IV) b/ VIIz,VIIIs,VIIIt v IV et pastille imprimée.	p1.33
505	72.302	1	5	6,2	6	5,6	C7	1	3+6	20	H	-	1	VIIIt b/ (VIIIs x VIIz) .	p1.33
506	72.306	1	4	7,2	8,7	-	C7	1	3	-	H	-	1	VIIz x VIIIs	p1.34
507	72.001	0	4	6,2	7,2	-	C8	1	3	+13	I	-	1	IV	-
508	72.012-11	0	4	9	9,2	-	C6	1	3+1	27	H	-	1	VIIIt2 b/[(VIIIs x VIIz)]	-
509	71.994-39	0	4	6,9	8	-	C6	1	3+1	18	A	-	1	VIIIt b/[VIIz x VIIIs] .	-
510	72.306-1	0	4	7	12	-	C8	1	3+1	22	H	-	1	VIIIf x VIIz x VIIIs3	-
511	71.988	0	4	8	11	-	C8	1	3+6	18	H	-	1	VIIIt3 b/?	-
512	72.001-10	0	4	5	7	-	C8	1	3	13	H	-	1	VIIIt2 b/[VIIIf x VIIz]	-
513	71.994-25	0	5	6,8	8,5	7,2	C8	1	3+6	+30	H	-	1	(VIIIt b/[VIIIs x VIIz] [VIIIt b/ VIIz]	-
514	72.313-4	0	5	5,8	6	7	C8	1	3+6	20	A	-	1	VIIIt b/[VIIIs x VIIz] [VIIIt b/ VIIz]	-
515	72.308-14	0	4	7	8,6	-	C8	1	3+6	18	A	-	1	VIIIt2 b/[VIIz x VIIIs]	-
516	71.993	0	5	7,2	7,7	6,5	C7	1	3+2+1	-	H	-	1	VIIIt2 b/[VIIz x VIIIs] VIIIt2 b/[VIIIf. x VIIz]	-
517	72.311-3	0	4	6	8,4	-	C7	1	3+2	14	A	-	1	VIIIt b/[IIz x IIs]	-
518	72.313-5	0	4	5,3	8	-	C8	1	3+1	27	A	-	1	VIIIt b/[VIIIs x VIIz]	-
519	72.001-17	0	4	9,7	8,4	-	C7	1	3	21	H	-	1	IIIt2 b/[VIIIs x IIz]	-
520	72.002-30	0	4	6,3	8,9	-	C6	1	3+7?	12	A	-	1	VIIIt2 b/[VIIIs x VIIz]	-
521	72.288	0	4	9,2	11,9	-	C7	1	3+1	28	H	-	1	VIIIt6	-
522	72.008	0	4	5,6	7,9	-	C7	1	3+7	-	A	-	1	VIIIt2 b/[VIIz x VIIIs]	-
523	72.014-13	0	4	7,2	9,3	-	C7	1	3+6	14	A	-	1	IIIt b/[IIz x IIs]	-
524	70.014-24	0	4	4	7	-	C7	1	3+6	13	A	-	1	VIIIt b/[VIIz x VIIIs]	-

1	2	3	4	5	6	7	8	9	10	11	12	13	14	15	16
525	72.008	0	4	6,3	8,5	-	C7	1	3+1	-	A	-	1	VIIIt2 b/[VIIIs x VIIz]	-
526	72.001-19	0	4	6,8	7,5	-	C8	1	3+7?	-	H	-	1	VIIIt3 b/[VIIz x VIIIs]	-
527	72.001-49	0	4	6,8	10	-	C7	1	3+6	-	H	-	1	VIIIt2 b/[VIIz x VIIIs]/b VIIIt.	-
528	72.304-11	0	4	6,4	7,6	-	C8	1	3+1	-	H	-	1	[VIIIt2 v IV] b/[VIIIf x VIIIs]	-
529	72.014-4	0	4	5,7	7,5	-	C7	1	3+1	-	A	-	1	VIIIt2 b/[VIIz b/ VIIIs]	-
530	71.991-2	0	6	-	8	7	C8	1	3+6	-	-	-	1	Erodé.	-
531	71.991-6	0	4	5,5	7,7	-	C7	1	3+1	23	H	-	1	VIIIt b/[VIIIf x VIIz]	-
532	72.001	0	4	6,3	9	-	C8	1	3+1	+26	A	-	1	VIIIt	-
533	72.469-1	0	5	6,4	9,2	8,2	C8	1	3+6	18	H	-	1	VIIIt2 v IV b/[VIIIs] [VIIIt2 v IV] b/[VIIIs b/ VIIIt2 v IV].	-
534	72.014-39	0	4	8,3	7,5	-	C7	1	3+1	-	H	-	1	VIIIt b/ VIIIs.	-
535	72.469-7	0	4	7,4	8,6	-	C7	1	3+1	14	H	-	1	VIIIt2 v IV b/[VIIIf x VIIIs]/b VIIIt2	-
536	71.978	0	4	6,6	10,6	-	C8	1	3+1	-	A	-	1	Erodé.	-
537	72.013	0	4	7,7	8	-	C6	1	3+1	26	A	-	1	VIIIt b/ IIIf.	-
538	72.313-1	1	5	4,7	6,6	6,4	C8	1	3+1	+19	H	-	1	VIIIt2 b/ traits curvilignes.Voir planche.pl.36	
539	73.111	1	5	7,2	9,7	8,8	C8	1	3+6	-	A	-	1	VIIIt b/ traits curvilignes.Voir planche. pl.36	
540	72.469-4	1	5	7,7	8,5	7,9	C8	1	3+6	20	A	-	1	(VIIIt2 v IV) b/[VIIIf x VIIIs].(VIIIt2 v IV) b/[VIIIf x VIIIs] /b(VIIIt2 v IV).	p1.32
541a	72.018-6	1	4	5,7	8,8	-	C7	1	3+1	22	A	-	1	VIIIt3 b/[LVIIIs ou z] /b VIIz ou s v IV.	p1.32
541b	72.001-6	1	4	8,3	9,3	-	C7	1	1	+16	A	-	1	IIIt b/ IIIf x feston./b VIIIt b/ VIIz.	p1.35
542	72.014-2	1	4	13,6	10	-	C7	1	3+1	+20	C	-	1	VIIz b/ VIIIs	p1.35
543	72.473-15	1	4	5,7	10,3	-	C7	1	3+6	19	I	-	1	IV,voir dessin.Roulette imprimée?	p1.35
544	72.453	1	4	6,2	11,5	-	C7	1	3+7?	25	I	-	1	IV,id. que 543.	p1.35

1	2	3	4	5	6	7	8	9	10	11	12	13	14	15	16
545	71.988	1	4	8,3	12,1	-	C8	1	3+6	-	H	-	1	VIIIt x VIIz x IV.	pl.34
546	72.301-1	1	5	6a8	10,5	9	C7	1	3+6	21	H	-	1	VIIIt b/ IIz x IIs3.IIIt b/ T ? IIz et s	
	72.001	"	"	"	"	"	"	"	"	"	"	-	"	x IV3.	pl.35
547	72.001-40	1	4	6,1	7,2	-	C8	1	3+1	15	I	-	1	IV.	pl.37
548	72.008-7	0	3	-	-	9,6	C7	1	3+2	-	-	-	1	VIIIs et z v IV	-
549	72.306	0	3	-	-	6,9	C8	1	1	-	-	-	1	VIIIs et z+IV.	-
550	72.469	0	3	-	-	9,1	C8	1	1+6	-	-	-	1	VIIIs /b VIIIt v IV	-
551	71.994-7	0	3	-	-	8	C7	1	1+3	-	-	-	1	VIIIs	-
552	72.296-3	0	3	-	-	9,6	C7	1	3+6	-	-	-	1	IV.VIIIs et z	-
553	72.473-13	0	3	-	-	9,2	C7	1	3+7	-	-	-	1	VIIIs x VIIz +IV.	-
554	72.292-3	0	3	-	-	9,8	C8	1	3+7	-	-	-	1	VIIIs	-
555	72.473-12	1	3	-	-	9,5	C7	1	3+2	-	-	-	1	VIIIt x VIIIf.VIIIs et z #IV.	pl.37
556	72.473-18	1	3	-	-	9,4	C7	1	3+6	-	-	-	1	Id;	pl.37
557	72.452	1	3	-	-	10	C8	1	3+7	-	-	-	1	Voir dessin.	pl.37
558	71.994-1	1	3	-	-	8	C8	1	3+7	-	-	-	1	Voir dessin.	pl.36
559	72.473-8	1	3	-	-	8,5	C7	1	3+7	-	-	-	1	Voir dessin.	pl.37
560	71.981-3	0	3	-	-	12	C6	1	3+2	-	-	-	1	VIIIs x VIIz +IV.	-
561	72.308-1	0	3	-	-	9,7	C8	1	3+6	-	-	-	1	?	-
562	72.313-13	1	3	-	-	10	C5etC8	1	2+3	-	-	-	1	IV.	pl.36
563	72.008-9	1	4	6,9	9,6	-	C7	1	3+1	13	H	-	1	Traits curvilignes.Voir dessin.	pl.36
564	72.022-5	1	5	8,4	10,8	9,6	C8	1	3+1	22	H	-	1	VIIIt3 b/[IIz et IIs]/b IV 1 b/[IIz et IIs].	pl.32
565	71.988	1	5	7,4	8,3	9,4	C5	1	3+1	18	H	-	1	Voir dessin.	pl.31

1	2	3	4	5	6	7	8	9	10	11	12	13	14	15	16
566	72.008-5 71.991	1	4	7,2	7,9	-	C7	1	3+1	22	H	-	1	VIIIt b/[VIIz er VIIIs]/b VIIIt b/[VIIz et VIIIs.+IV].	pl.31
567	72.304-5	1	4	9,7	7	-	C6	1	3+6	-	A	-	1	IIIt6 b/[VIIs x VIIz]	pl.31
568	71.983	1	5	6,5	6,6	6,6	C8	1	3+6	24	A	-	1	IIIt b/[IIIs et IIIz]/b IIIt b/[IIIz et IIIs]/b IIIt.	pl.39
569	72.014-8	1	4	8	9,9	-	C5	1	3+1	33	H	-	1	IIIs x IIz	pl.30
570	72.323-1	1	4	8	8,8	-	C8	1	3+2	29	A	-	1	IIIt x IIIf	pl.30
571	71.983-2	0	4	7,3	8,2	-	C7	1	3+2	+30	C	-	1	VIIz b/ VIIIs	-
572	71.992-1	0	4	7	11,6	-	C7	1	3+2	+30	A	-	1	VIIIt2 b/ IIIz b/ IIIIs	-
573	72.292-2	0	4	11,5	10	-	C6	1	3+6	+30	H	-	1	VIIIf x VIIIt	-
574	72.008-8	0	4	7,3	9,4	-	C5	1	3+1	26	A	-	1	VIIIt2 b/[IIIz b/ IIIIs]	-
575	72.020 72.449	0	4	7,5	-	-	C8	1	3+1	24	H	-	1	VIIIt b/[VIIz b/ VIIIs]	-
576	72.022-6	0	4	7	10,5	-	C8	1	3+2	-	A	-	1	? Erodé.	-
577	71.994-10	0	4	6	8,9	-	C6	1	3+6	25	A	-	1	Erodé.	-
578	71.983-18	0	4	6,2	9,3	-	C5	1	3	+23	A	-	1	VIIIt b/ VII>>z.	-
579	72.306-11	0	4	6,7	10	-	C8	1	3	27	A	-	1	VIIIt b/ VIIz b/ VIIIs	-
580	72.306-4	0	4	7,7	10	-	C8	1	3+1	23	A	-	1	IIz	-
581	72.290-11	0	4	4,6	9,3	-	C5	1	3+1	-	A	-	1	IIIs et z.Erodé.	-
582	71.994-41	0	11	-	-	-	C7	1	3+6	-	-	-	-	Ep.=14,5.Fond plat.	-
582	72.018-23	0	11	-	-	-	C8	1	3+6	-	-	-	-	Ep.=13.Fond plat.	-
583	72.304-8	0	11	-	-	-	C7	1	3+6	-	-	-	-	Ep.?.Fond plat.	-

1	2	3	4	5	6	7	8	9	10	11	12	13	14	15	16
584	72.288-15	0	11	-	-	-	C8	1	3+6	-	-	-	-	Ep.14.Fond plat.	-
585	71.988-15	0	11	-	-	-	C8	1	3+6	-	-	-	-	Ep.10.Fond plat.	-
586	71.018-24	0	11	-	-	-	C8	1	3+6	-	-	-	-	Ep.15,5.Fond convexe.	-
587	72.304-6	0	11	-	-	-	C7	1	3+6	4,7	-	-	-	Ep.15,7.Fond plat.	-
588	72.306-2	0	11	-	-	-	C6	1	3+6	-	-	-	-	Ep.?Fond plat.	-
589	72.308-3	0	11	-	-	-	C8	1	3+1	6,8	-	-	-	Ep.9.Plat.	-
590	71.988-14	0	11	-	-	-	C8	1	3+1	-	-	-	-	Ep.11,2.Fond plat.	-
591	72.014-1	0	11	-	-	-	C7	1	3+6	-	-	-	-	Ep.?Fond plat.	-
592	72.304-1	0	11	-	-	-	C5	1	3	-	-	-	-	Ep.19,5.Fond plat.	-
593	71.983-51	1	11	-	-	-	C1/C8	1	3+1	6,2	-	-	-	Ep.7.Fond plat.	p1.39
594	71.994	1	11	-	-	-	C6	1	3+2	6,7	-	-	1	Ep.8,8.Fond plat.IIs /b IIt.	p1.39
595	72.332-2	1	11	-	-	-	C8	1	3+6	9,0	-	-	1	Ep.11.Fond plat.IIs x IIz.	p1.39
596	72.320-1	1	11	-	-	-	C8	1	3+6	8,8	-	-	-	Ep.11.Fond plat.	p1.39
597	72.283-4	1	3	-	-	9,4	C6	1	3+2	-	-	-	1	IV creux.IIz.Impressions d'un "filet".	p1.38
598	71.988-4	1	3	-	-	8,5	C7	1	3+1	-	-	-	1	IV creux.IIz b/ IIIs.	p1.38
599	71.983-30	1	3	-	-	7,2	C7	1	3+1	-	-	-	1	IV creux.VIIz b/ VIIIs	p1.38
600	72.018-11	1	5	4,7	6,7	6,4	C7	1	3+2	+12	A	-	1	III.IIz et IIs.	p1.40
601	72.306	1	4	6,7	9,8	-	C7	1	3+1	27	H	-	1	IV l.sur deux rangs;IIz x IIs.	p1.40
602	72.018-18	0	4	5,8	8,3	-	C6	2	3+1	-	-	-	1	Id.	-
603	72.008-4	1	3	-	-	7,8	C7	1	3+1	-	-	-	1	VIIIs x VIIz;III x III.Diamètre à la panse = 23 cm.	p1.40
604	72.336-6	1	3?	-	-	4,2	C7	1	1	-	-	-	1	T IIIs b/ IIIz.	p1.38
605	72.292-6	1	3?	-	-	4,2	C8	1	1	-	-	-	1	IX; IIz.	p1.38

1	2	3	4	5	6	7	8	9	10	11	12	13	14	15	16
606	72.292-5	0	3	-	-	5,9	C7	1	3+1	-	-	-	1	IIs x IIz.	-
607	71.983-7	1	4	7,5	8	-	C6	1	3+1	15	A	-	1	IIIt6 b/ [IIz et IIs].	pl.38
	72.469-9	"	"	"	"	-	"	"	"	"	"	-	"	"	"
608	72.304-16	1	4	6,3	7,7	-	C8	1	3+1(5?) <u>+20</u>	A	-	-	1	IV multiples et IIIt.	pl.38
609	71.994-5	1	4	8,6	7,5	-	C8	1	2	28	A	-	1	Voir planche.Matrice (?) imprimée.	pl.41
610	72.310-1	1	4	5,4	8	-	C8	1	2	22	H	-	1	Id.	pl.41
611	72.006-2	0	3	-	-	6,8	C7	1	2+1	-	-	-	1	Id.	-
612	72.006-4	1	4	6,7	6,6	-	C6	1	2	<u>+30</u>	A	-	1	Id.	pl.41
613	72.006-6	0	3	-	-	6	C7	1	2	-	-	-	1	Id.	-
614	72.313-3	1	3	-	-	9	C8	1	2+1	-	-	-	1	Id.	pl.41
615	72.313-19	0	4	6	6	-	C6	1	2+1	-	F	-	1	Id.	-
616	71.964-2	0	4	6,4	-	-	C7	1	2	-	A	-	1	Id.	-
617	72.469-19	0	2	-	6,6	-	C7	1	2	-	-	-	1	Id.	-
618	71.983	0	4	8	6,4	-	C8	1	2+3	<u>+30</u>	A	-	1	Id.	-
619	72.304-2	0	3	-	-	8,6	C7	1	2	-	-	-	1	Id.	-
620	72.444-6	0	3	-	-	7,5	C8	1	3+2	-	-	-	1	Id.	-
621	72.359	0	3	-	-	7,3	C7	1	2+1	-	-	-	1	Id.	-
622	71.983-5	0	2	-	8,8	-	C6	1	3+2	-	-	-	1	Id.	-
623	72.001-11	0	3	-	-	7,8	C8	1	3+2	-	-	-	1	Id.	-
624/	72.469-18	0	3	-	-	7,3	C6	1	3+2	-	-	-	1	Id.	-
625	72.012-112	0	4	5,8	6,6	-	C8	1	2+3	-	A	-	1	Id.	-
626	72.006-5	0	2	-	6	-	C6	1	2	-	-	-	1	Id.	-

1	2	3	4	5	6	7	8	9	10	11	12	13	14	15	16
627	72.006-26	0	2	-	7,3	-	C6	1	2+3	-	-	-	1	Id.	-
628	72.006-2	0	2	-	6,9	-	C5	1	2	-	-	-	1	Id.	-
629	72.474-8	0	3	-	-	7	C8	1	2	-	-	-	1	Id.	-
630	72.006-8	0	3	-	-	7	C7	1	2+3	-	-	-	1	Id.	-
631	72.290-2	0	3	-	-	6,6	C8	1	2+3	-	-	-	1	Id.	-
632	72.474-3	0	3	-	-	8,2	C8	1	2+3	-	-	-	1	Id.	-
633	72.313-9	0	3	-	-	9,2	C7	1	3+2	-	-	-	1	Id.	-
634	72.006-15	0	3	-	-	6,7	C6	1	2	-	-	-	1	Id.	-
635	72.306-22	0	4	5+3	-	9	C6	1	2	22	A	-	1	Id.	-
636	72.006-14	0	3	-	-	7	C5	1	2	-	-	-	1	Id.	-
637	72.008-7	1	6	-	7,2	5,8	C7	1	2+1	-	-	-	1	Id.	pl.41
638	72.290-13	0	3	-	-	6,9	C5	1	2+1	-	-	-	1	Id.	-
639	72.000-23	0	2	-	8,6	-	C5	1	2+3	-	-	-	1	Id.	-
640	71.98?-9	0	3	-	-	8	C8	1	3?	-	-	-	1	Id.	-
641	71.981-5	0	4	7,4	10,4	-	C8	1	3+1	-	H	-	1	Id.	-
642	72.001-37	0	3	-	-	10	C6	1	2+3	-	-	-	1	Id.	-
643	71.993-4	0	1	9,2	-	-	C5	1	2+1	-	H	-	1	Id.	-
644	72.325-8	0	3	-	-	6,2	C6	1	6	-	-	-	1	Id.	-
645	72.006-27	0	2	-	6,5	-	C5	1	2+3	-	-	-	1	Id.	-
646	71.993	0	1	6	-	-	C5	1	2+5	-	H	-	1	Id.	-
647	72.469-17	0	3	-	-	6	C7	1	2	-	-	-	1	Id.	-
648	71.994-13	0	3	-	-	7,6	C8	1	2	-	-	-	1	Id.	-

1	2	3	4	5	6	7	8	9	10	11	12	13	14	15	16
649	72.022-8	0	2	-	7	-	C8	1	2	-	-	-	1	Id.	-
650	72.304-18	0	4	7,3	8,9	-	C5	1	2+1	-	A	-	1	Id.	-
651	72.012-14	1	4	8,2	10	-	C5	1	2+3	-	H	-	1	Id.	pl.41
652	72.313-18	0	4	4,4	7	-	C6	1	2+3	-	A	-	1	Id.	-
653	71.988-28	0	3	-	-	7	C8	1	2+3	-	-	-	1	Id.	-
654	72.304-19	1	1	6,8	-	-	C8	1	2	-	A	-	1	Id.	pl.41
655	70.270	1	5	4,6	6	7,2	C7	1	2+1	15	A	-	1	IIz2 et IIIs2;III	pl.40
656	70.265	1	5	5,9	-	7	C4	2	2+1	18	H	1	1	Mode 1,Groupe II.	pl.40
657	70.264	1	6	-	5,6	6,4	C4	2	2+3	-	-	-	1	VIIz et VIIIs.	pl.40
658	70.271	0	3	-	-	5,2	C6	1	2	-	-	-	1	IV.	-

2. INVENTAIRE METALLIQUE: (3).

MISENGA:

n° d'inv.	n° M.R.A.C.	nature	métal	situation	dimensions	dess/n.dess. planche	
M.1	70.620-1	bracelet	cuivre	piquet 83	voir texte.	1	14
M.2	70.620-2	anneau	cuivre	-	Id.	1	14
M.3	70.628-5	alène	cuivre	-	L.=84,2; l.=7; ép.=2,8 mm.	0	-
M.4	70.628-6	alène	cuivre	-	L.=78,5; l.=6,5; ép.=2,7 mm.	0	-
M.5	70.628-4	alène	cuivre	-	L.=89; l.=5,7; ép.=2,2 mm.	1	14
M.6	70.620-3	hameçon?	cuivre	piquet 112	diam.max.=2,3 mm.	0	-
M.7	70.620-4	crochet	cuivre	piquet 110/113	L.=42,5; ép.max.=10 mm.	0	-
M.8	70.620-6	fragment d'épingle	cuivre	piquet 112	L.conservée=32; diam.=3 mm.	0	-
M.9	70.610	objet in- forme.	cuivre	+ -30 cm.	L.=35; ép.max.11 mm.	0	-
M.10	70.620-5	fragment de barre qua- drangulaire	cuivre	piquet 83	ép. des cotés=4,8 mm.	-	-
M.11	70.620-7	petite mas- se.	cuivre	-	-	-	-
M.12	70.628-1à3	trois masses (scories?)	cuivre	-	-	-	-
N.B.: l'une d'elles (70.628-1) a, soudé à sa masse, un petit anneau en cuivre.							
M.13	70.545	anneau	cuivre	+ -25 cm.	Gd.axe=37; Pt.axe=28 mm.	-	-
M.14	70.600	Trois frag- ments.	fer	-25 cm.	-	-	-

M. 15	70.621	fragments	fer	piquet 83	-	-	-
M. 16	70.694	fragment mésial de lame.	fer	-	-	-	-
M. 17	70.709	masse mé- tallique.	fer	-	-	-	-
M. 18	70.703	4 scories	fer	+ -50 cm.	-	-	-
M. 19	70.593	3 scories	fer	+ -25 cm.	-	-	-
<u>MAN TSE TSI:</u>							
M. 20	72.624	6 petites scories.	fer	puits 3	-	-	-
M. 21	72.891	24 petites scories.	fer	puits 16, -15à-25 cm.	-	-	-
M. 22	72.897	1 scorie	fer	puits 16, -25 cm.	-	-	-
M. 23	72.903	3 scories	fer	puits 16, -30 cm.	-	-	-
M. 24	72.911	32 petites scories.	fer	puits 16, -38 cm.	-	-	-

M.25	72.914	58 petites fer et moyennes scories.	puits 16,-39 cm.
M.26	72.917	17 petites fer et moyennes scories.	puits 16,-48 cm.
M.27	72.919	2 petites scories. fer	puits 16,-67 cm.
M.28	72.923	2 scories fer	puits 16.
	72.926	" "	"
M.29	72.936	1 scorie fer	puits 16Y.
M.30	72.932	23 scories fer	puits 16Y,-27 cm.
M.31	72.955	fragments fer de lames.	puits X,-24 cm.
M.32	73.019	fragment de fer dame.	puits 25,humus.
M.33	73.011	2 scories. fer	puits 21.
M.34	73.043	38 scories fer	puits 16,-65 cm.
KINDU II :			
M.35	72.505	fragments fer	puits 7.
M.36	72.489	fragments fer (d'un anneau?)	puits 3.

SUMBI :							
M.37	72.328	4 scories	fer	-	-	-	-
	72.361						
	72.321						
	72.470						
M.38	71.997	fragments d'hameçon?	cuivre	puits 17-18.			
M.39	71.984	fragments d'anneau?	fer	puits 16.			
M.40	72.023	2 scories	fer	-	-	-	-
	72.015						
M.41	72.297	petit an- neau.	cuivre	puits 24-33.	-	-	-
M.42	72.281	barre de sec- tion quadran- gulaire.	cuivre	puits 20-33	L.=47,6;l.=6,6;ép.=3 mm.	-	-
M.43	72.019	crochet	cuivre	puits 19/20.			
M.44	72.004	fragment distal de lame.	fer	puits 17-20	L.=45,5;l.=28,3;ép.3,8 mm.	-	-
M.45	72.005	lame	fer	puits 17-24.	-	-	-
M.46	72.475	applique	fer	puits 42.	-	-	-

3. INVENTAIRE LITHIQUE (4):

MAN TSETSI :

n° Inv.	n° M.R.A.C.	typologie	matériau	dimensions (L x l x ép.) mm	tranch.	1. poids (gr.)	localisation	pl.
L.1	72.662	Hache polie	?	115,4x72x29,6	60	345	Argile,-28 cm. Puits 3.	44
L.2	73.028	Hache polie	?	113,3x68,2x25,2	63,3	495	Argile, Tranchée 1.	44
L.3	73.097-2	Armature transverse.	Quartz	26,6x22,5x8	22,5	-	Argile, piqu.5 puits V.	44
L.4	72.665	Armature transverse.	Quartz	37x28x8	-	-	Argile "bouleversée", Puits 3 ter.	44
L.5	72.652	Biface lancéolé (ou poignard).	Grès polymorphe	144,2x43,5x19,5	-	-	Sommet de la latérite, puits 3bis.	45
L.6	72.830	Biface lancéolé.	Grès polymorphe	138,6(cassé!)x39x20,4	-	-	Puits 10?	45
L.7	72.667	Pointe de biface lancéolé.	Grès polymorphe	74,7x37,5x20	-	-	Argile bouleversé. Puits 3ter.	45
L.8	72.692	Biface foliacé.	Grès polymorphe	87,5x41,5x24	-	-	Tranchée 1	45
L.9	72.644	Hache ou pic.	Grès polymorphe	235x65x30,5	-	-	Latérite, puits 3 extension.	45
Kindu II:								
L.10	72.592	Hache polie	?	108x74x28		295	Argile,-16 cm. Puits 6.	46
SUMBI:								
L.11	-	Base de biface lancéolé.	Grès polymorphe	61,7x34,6x16,6	-	-	-	44

NOTES:

1. Voir légende du tableau au Chapitre III.
2. Cet indéterminé procède d'un matériau blanchâtre, finement pilé.
3. Tous les objets de ce type présents dans la collection MRAC sont repris ici.
4. Les quelques objets lithiques repris dans cet inventaire sont illustrés aux planches indiquées.

2° PARTIE :

ICONOGRAPHIE; PLANCHES.

8.11

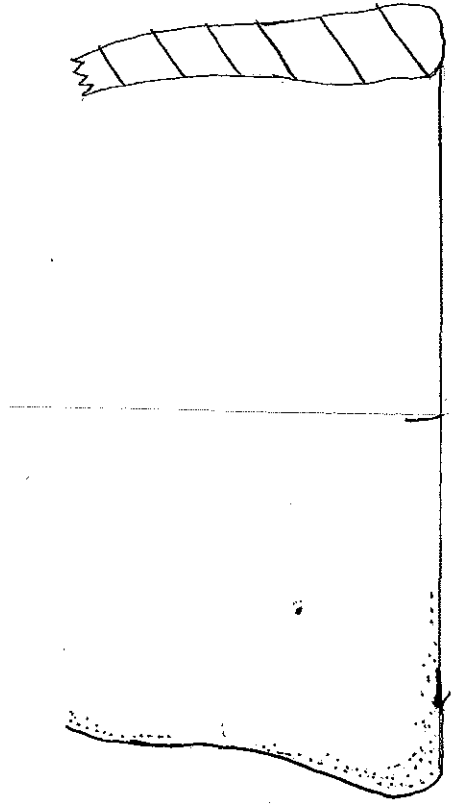

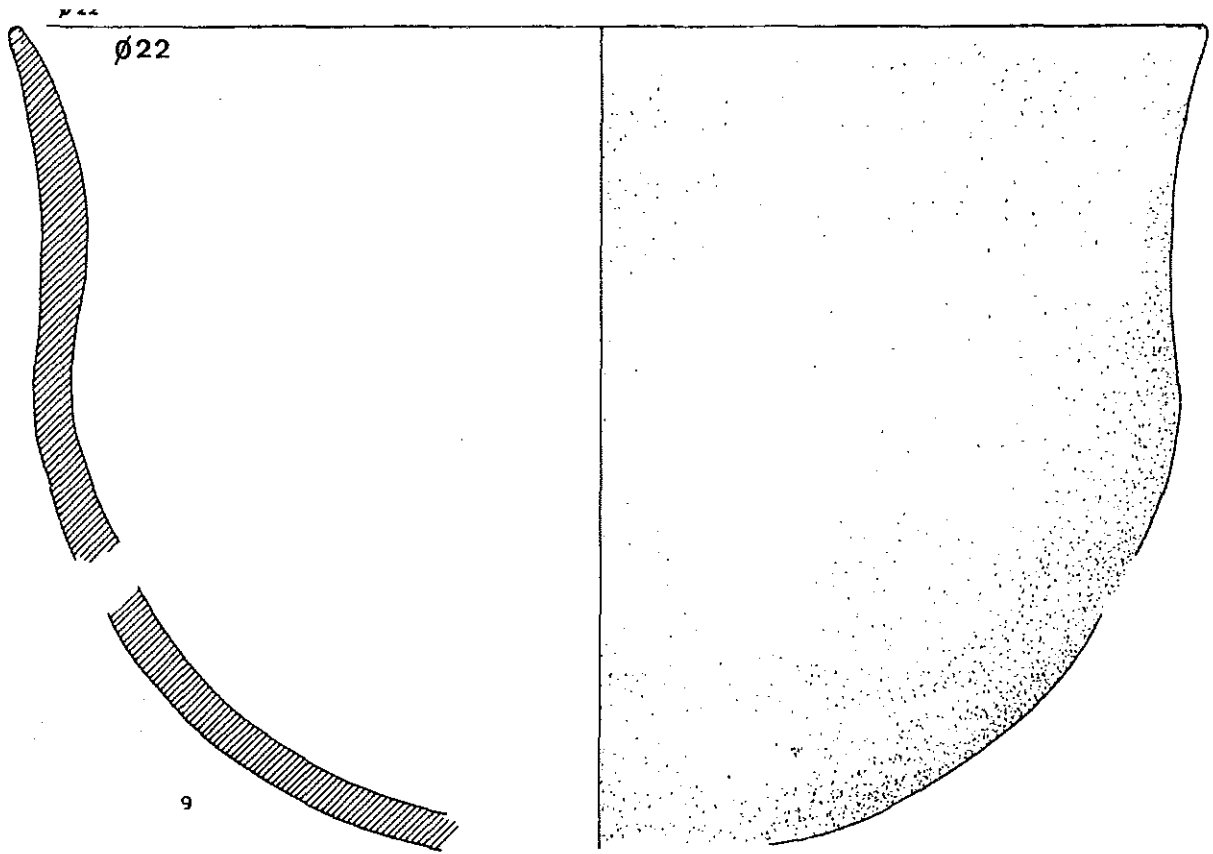

PL.1

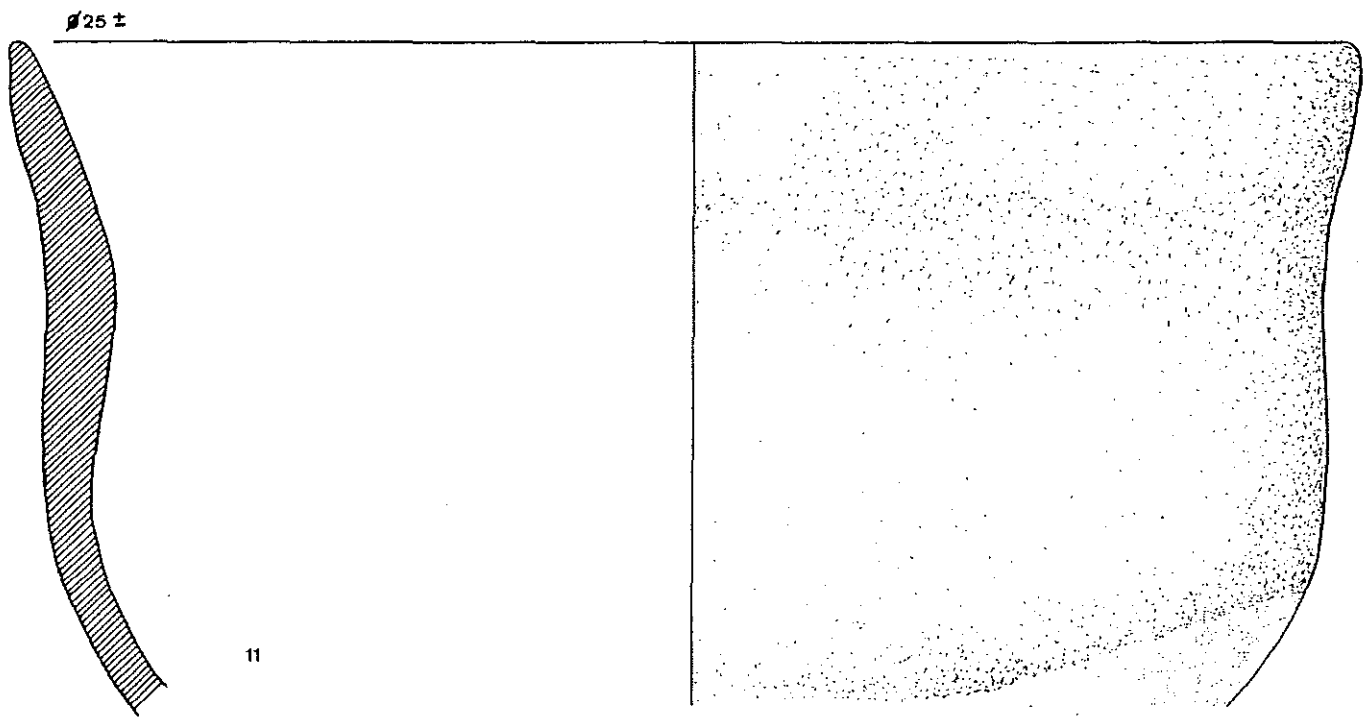

MISENGA

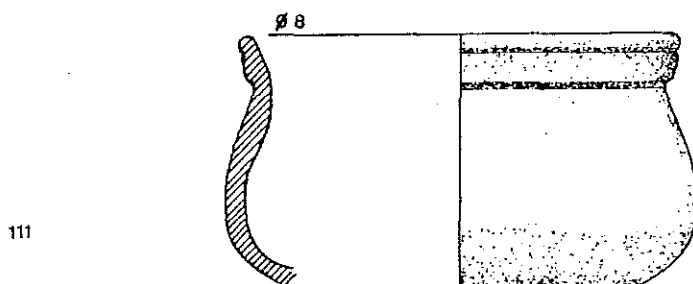

128

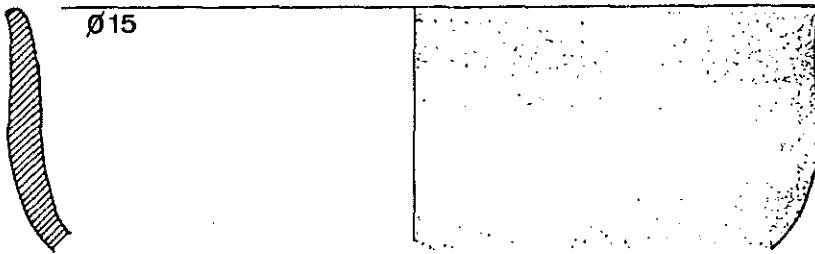

12

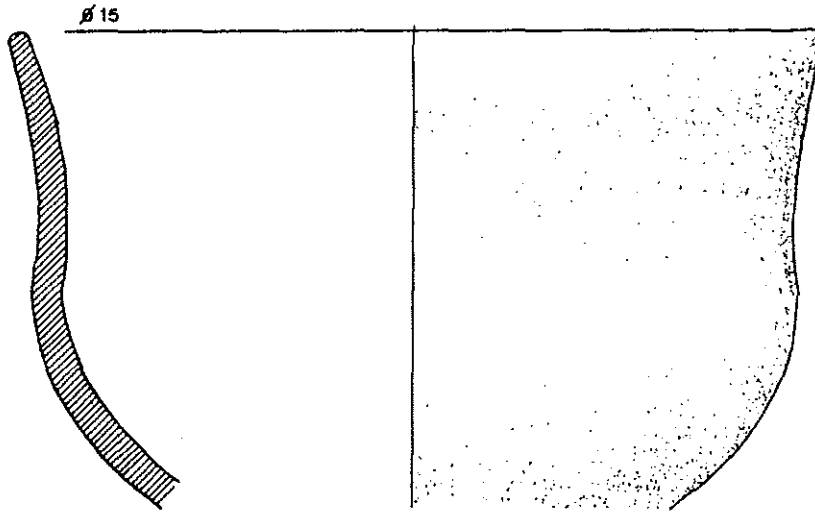

14

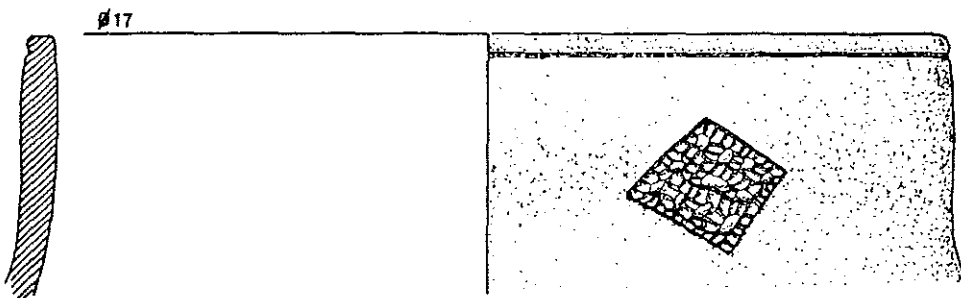

115

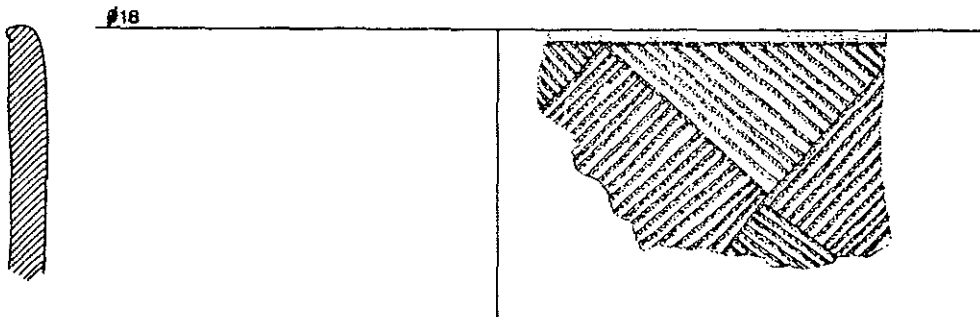

MISENGA

58

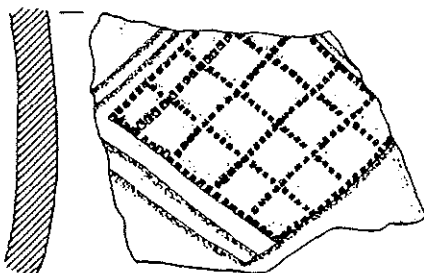

60

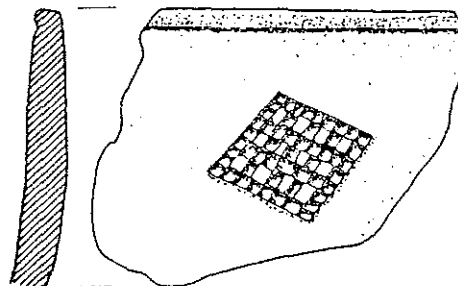

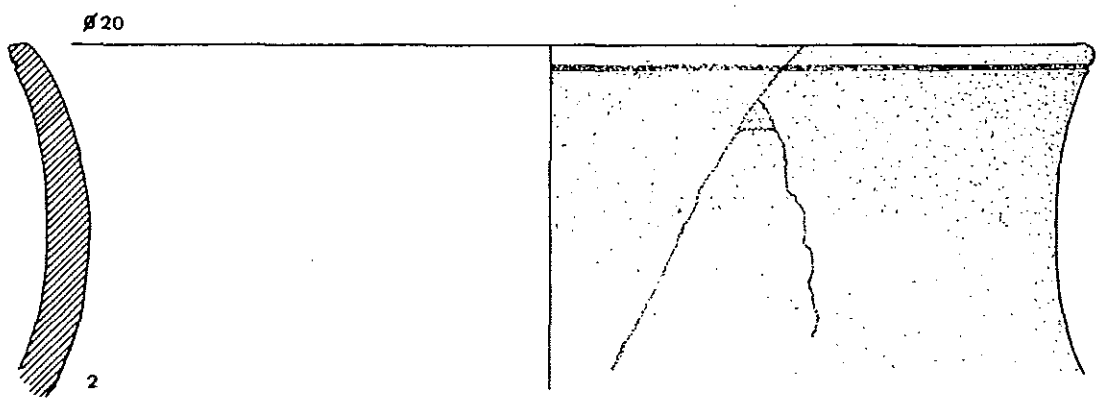
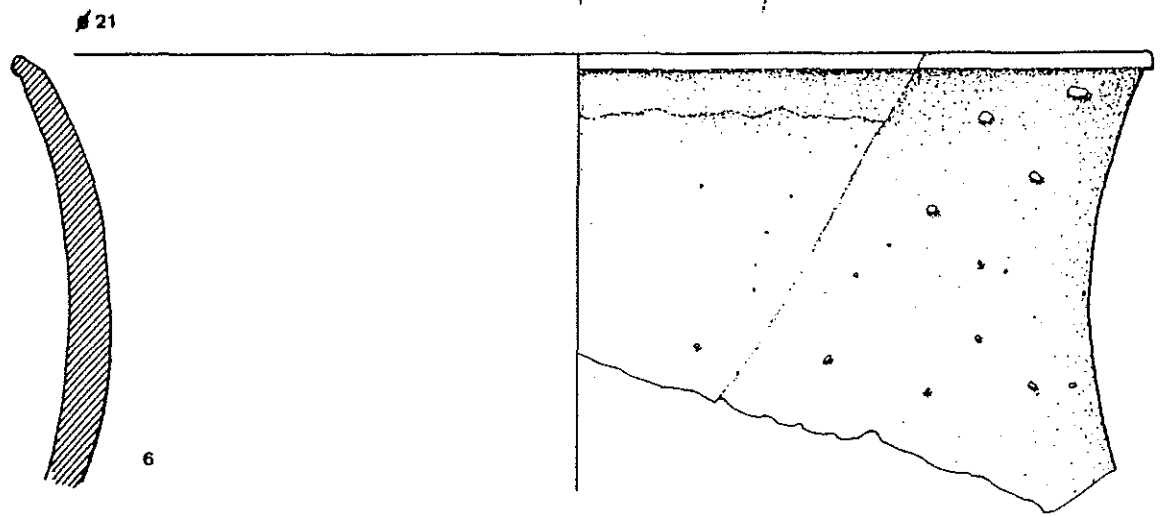
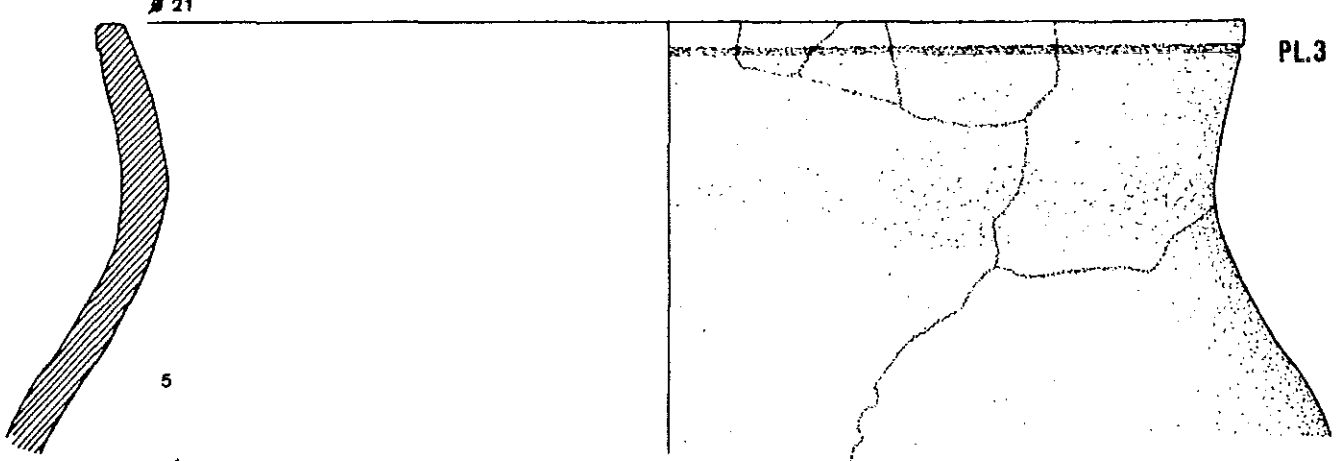

MISENGA

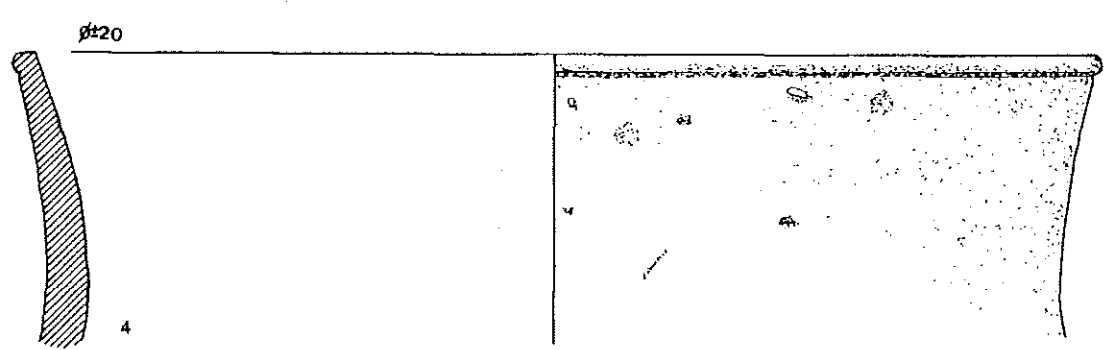
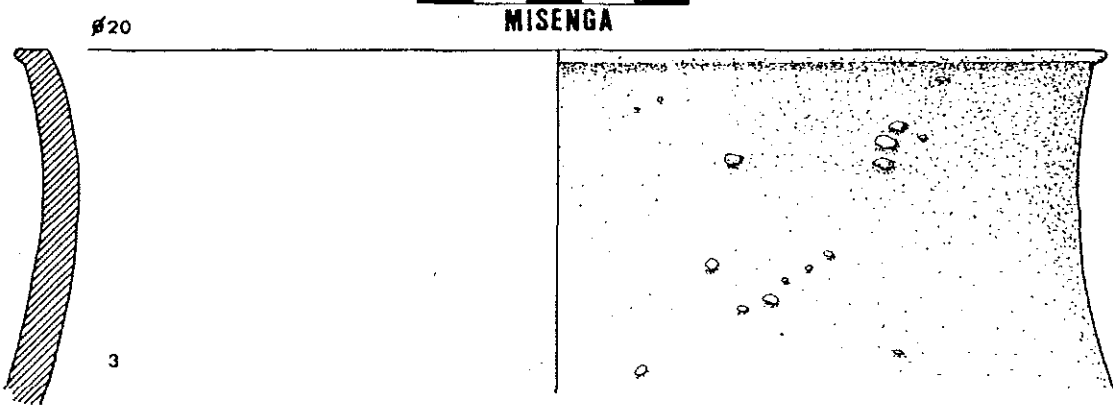

69

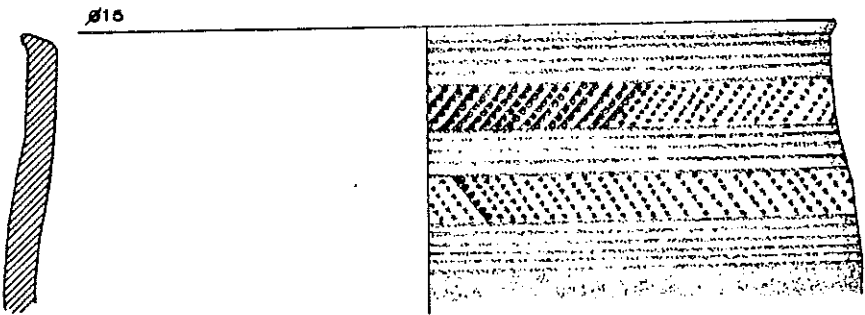

129

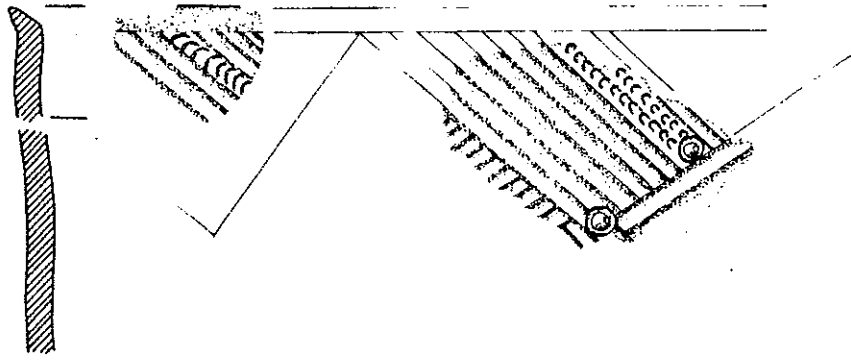

MISENGA

130

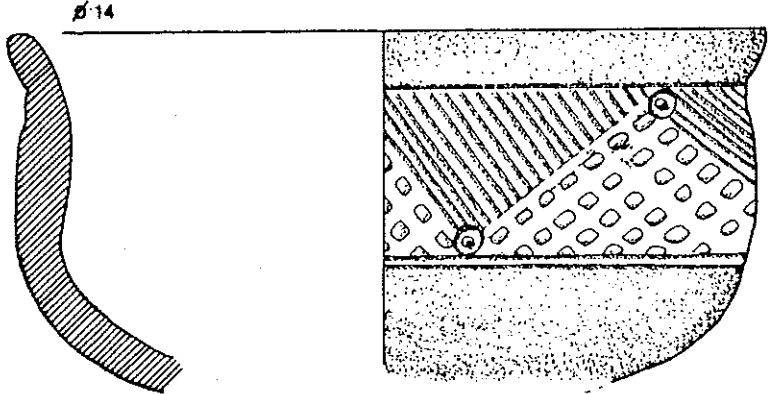

109

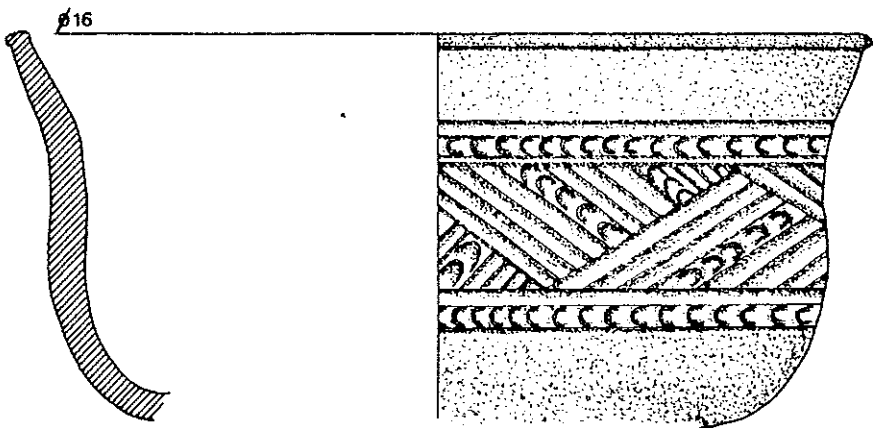

172

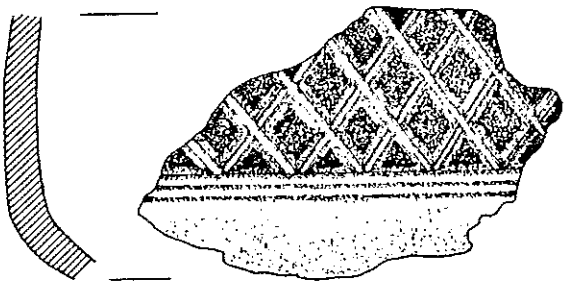

71



72



$\varnothing 15$

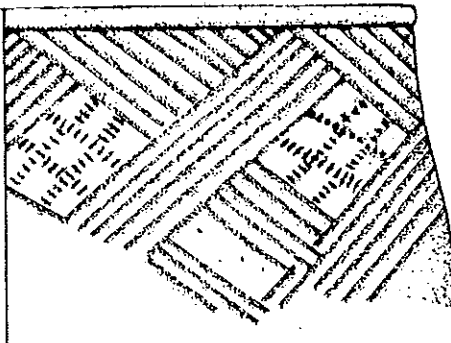

67

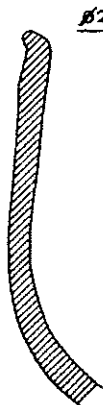

$\varnothing 20 \pm$

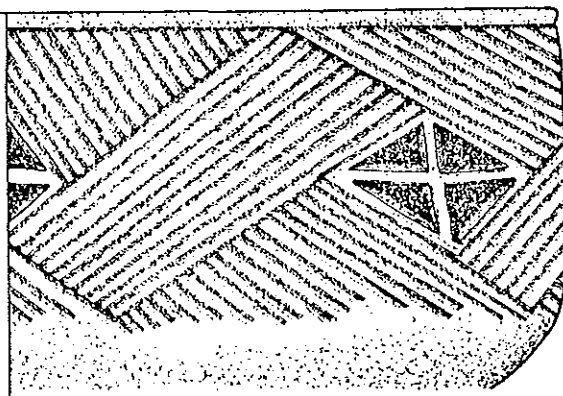

63

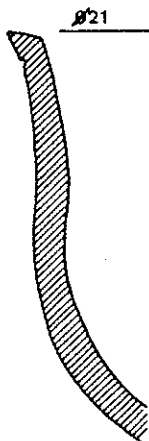

$\varnothing 21$

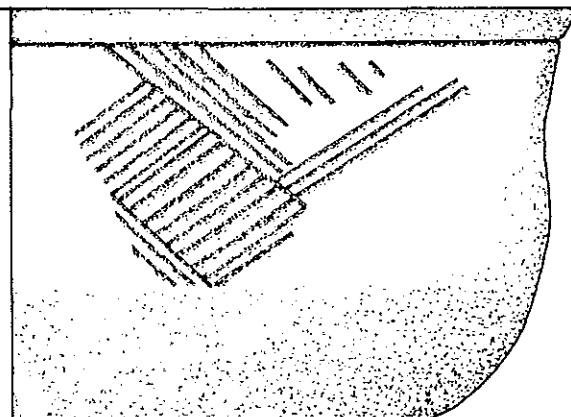

$\varnothing 18$

MISENGA

73

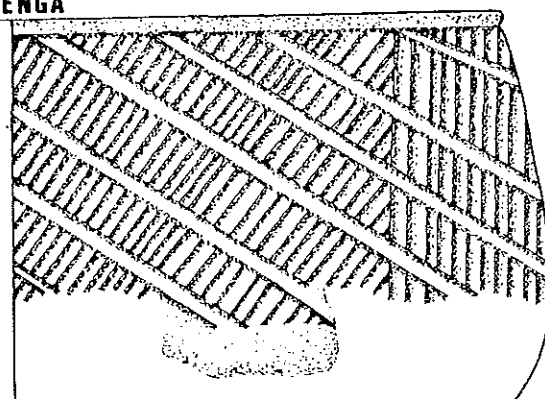
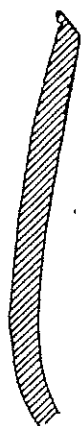

68

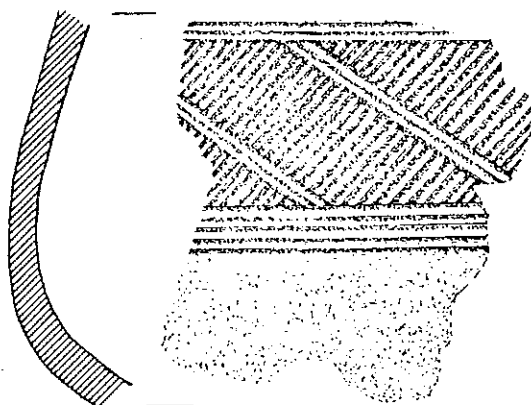

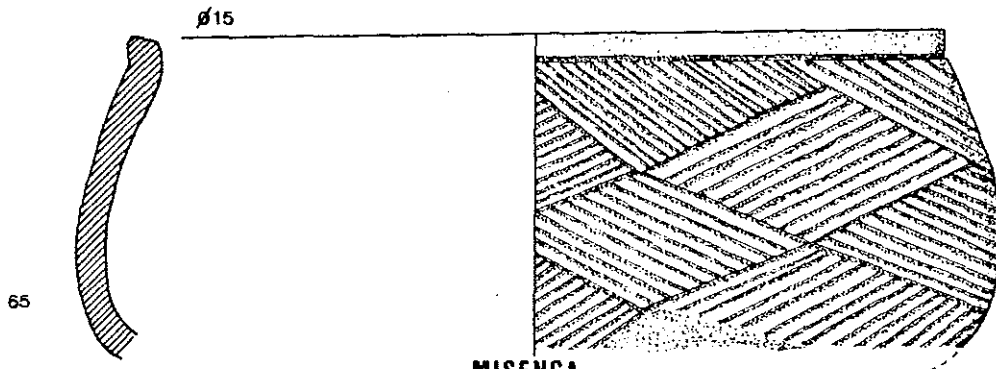
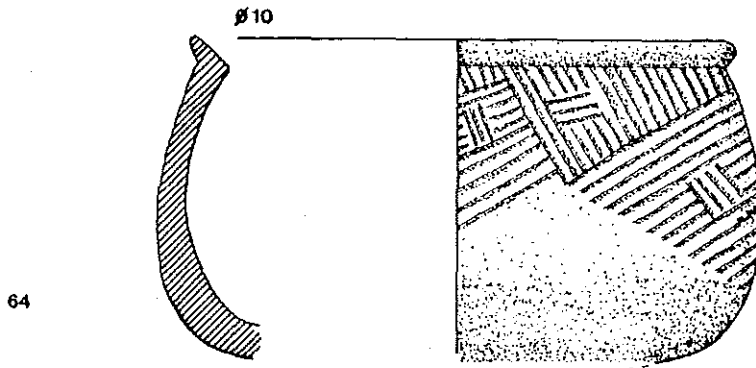
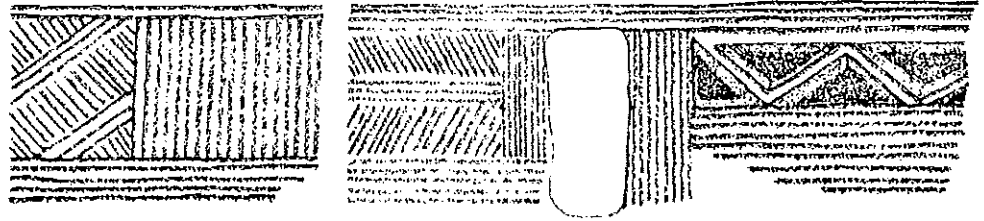
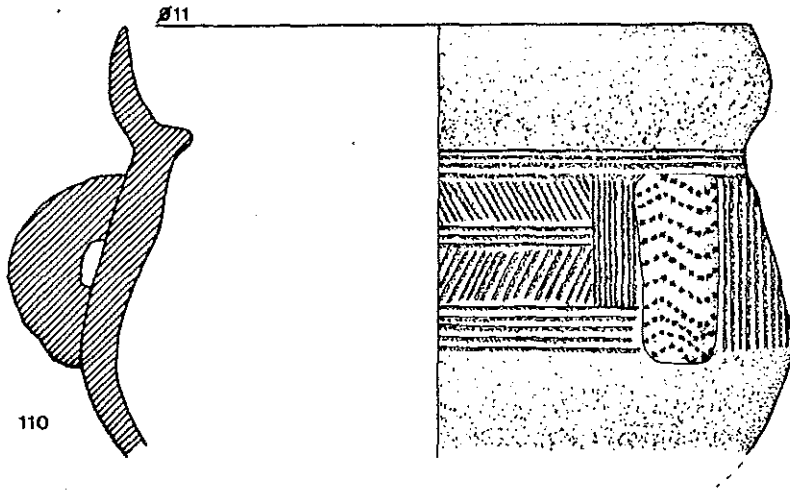

MISENGA

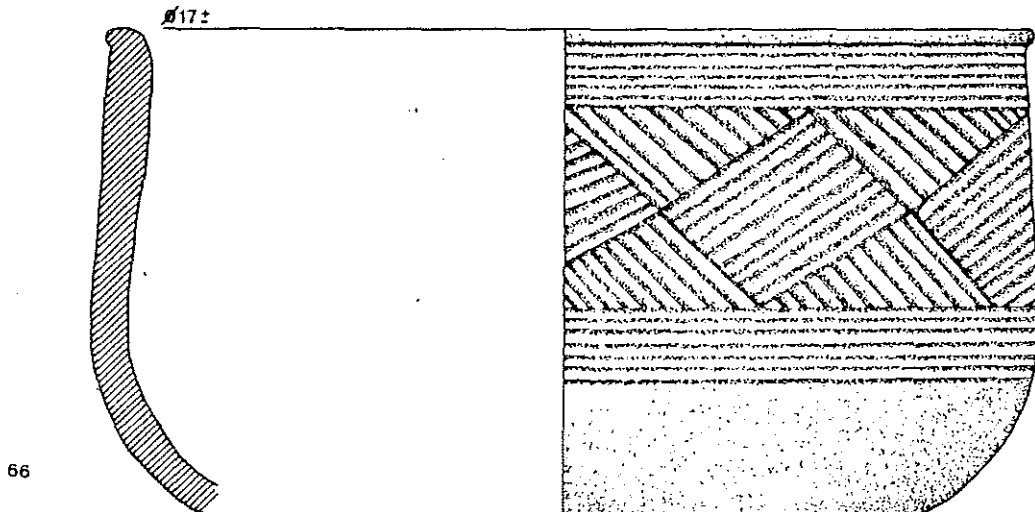

79

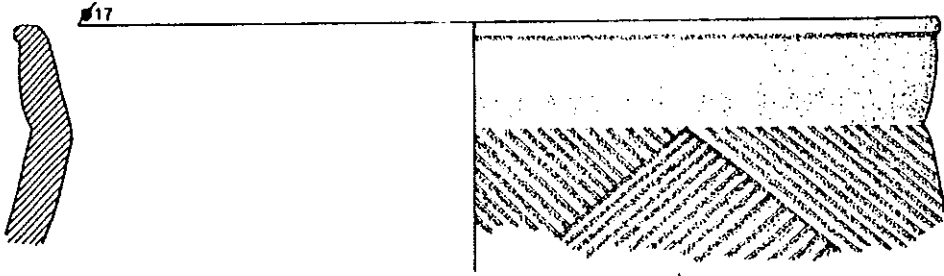

81

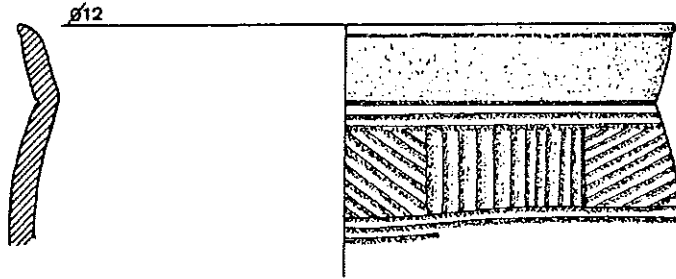

78

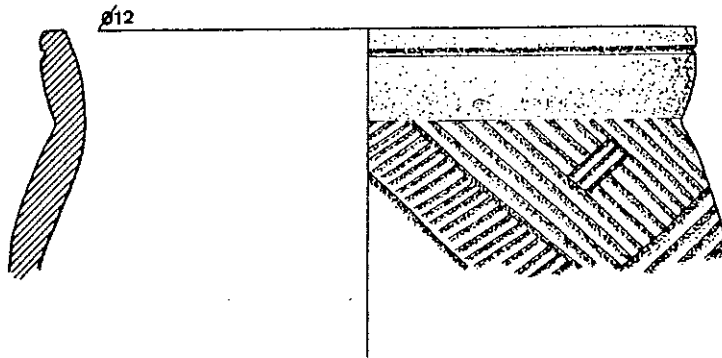

80

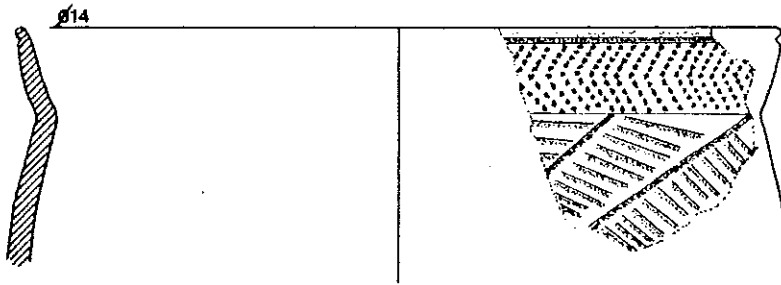

98



MISENGA

77

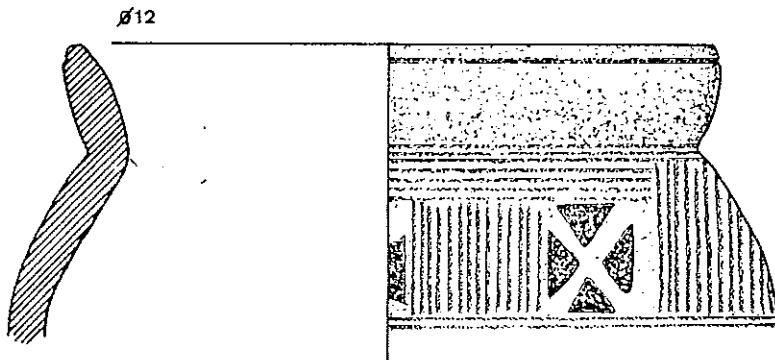

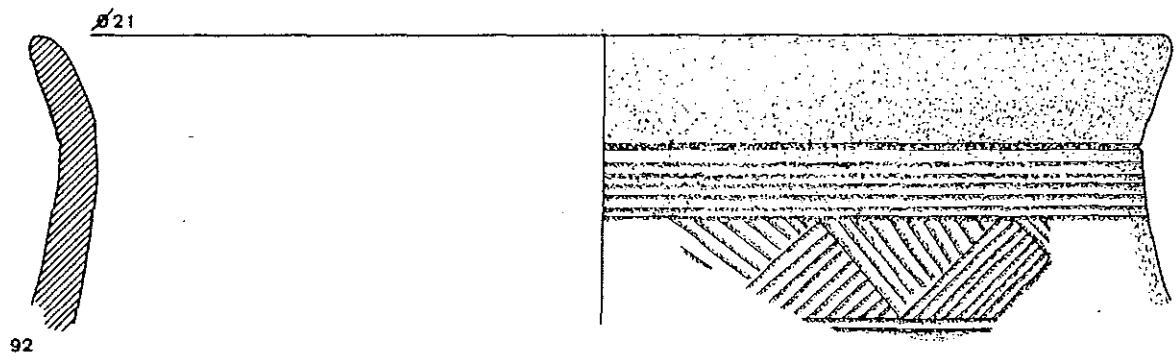
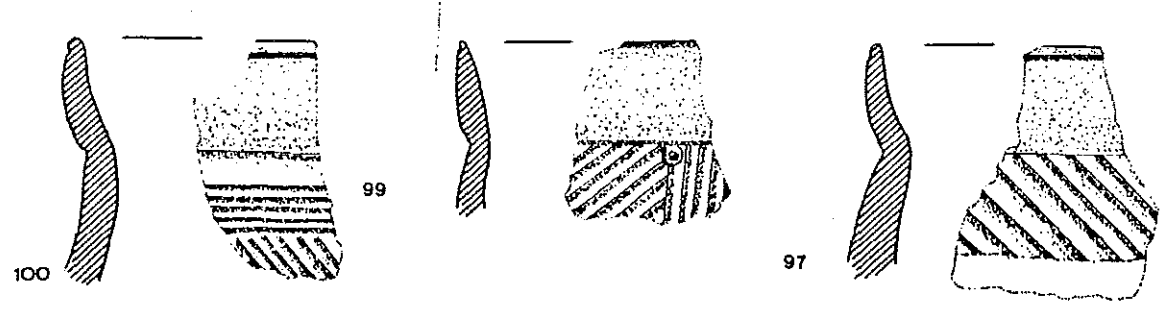
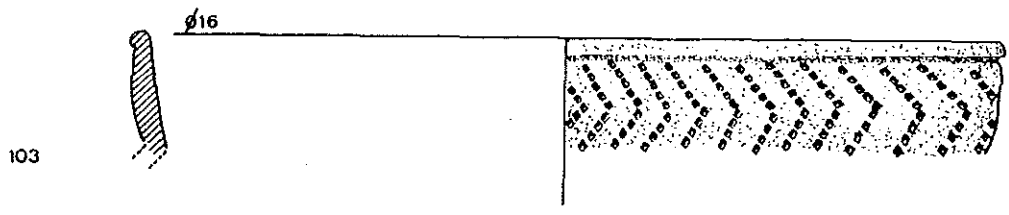
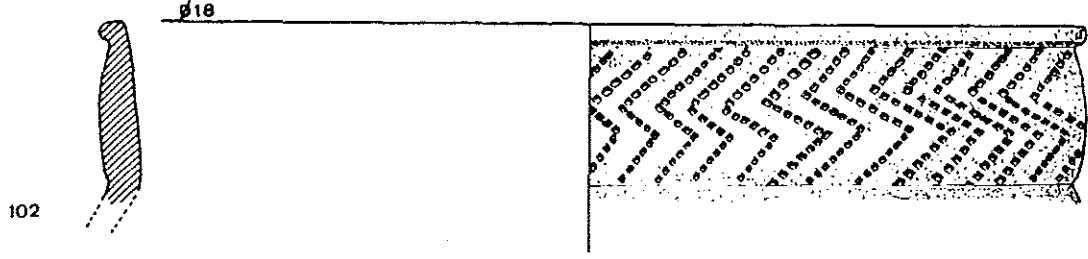

MISENGA

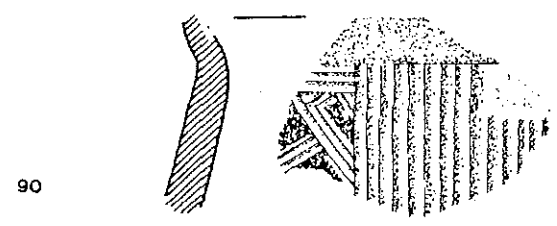
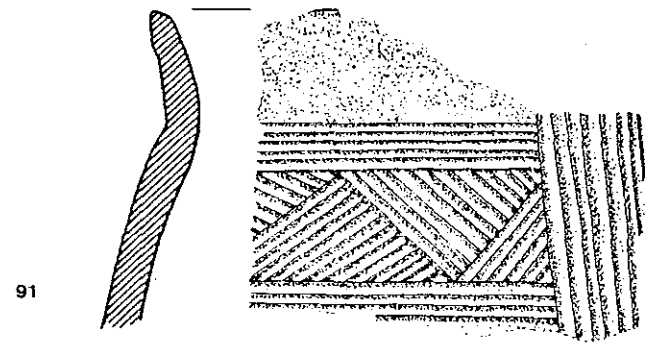

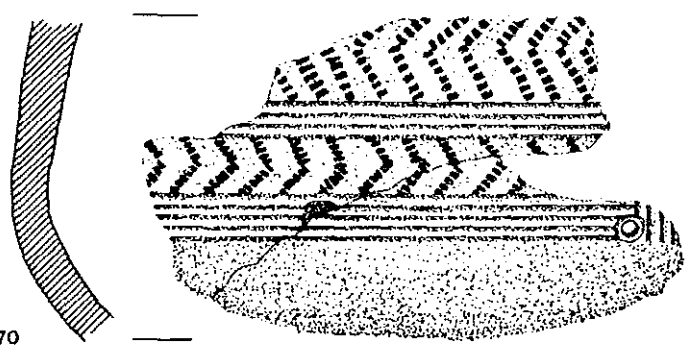
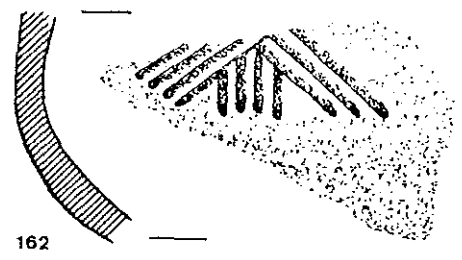
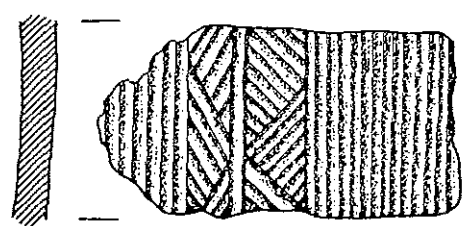
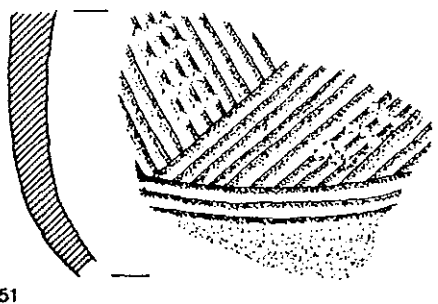
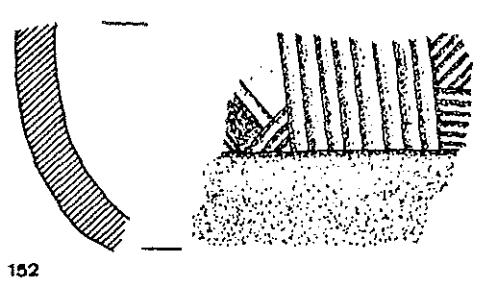
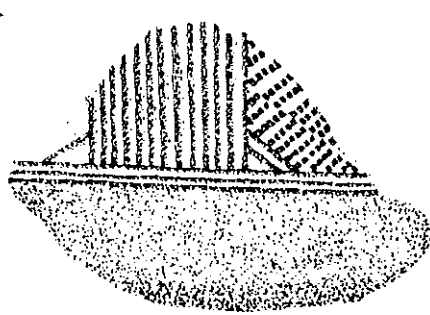
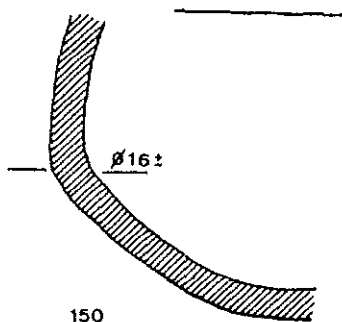

MISENGA

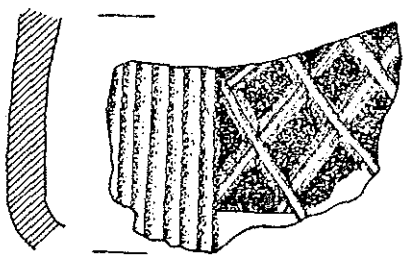
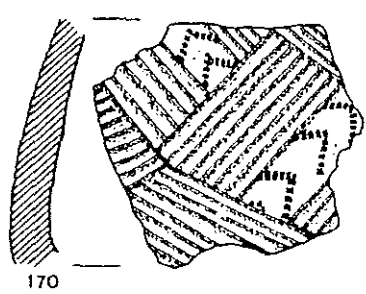
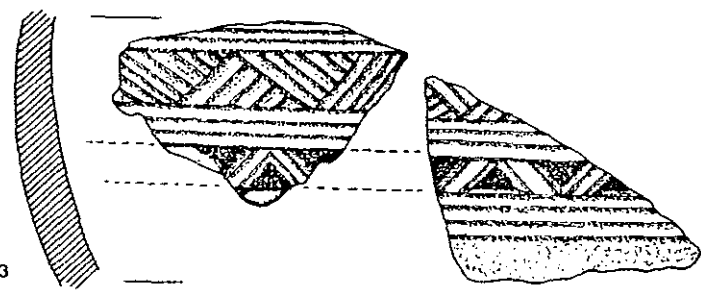
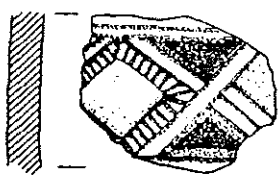

167

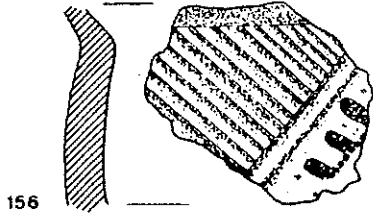
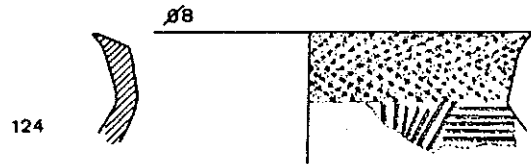
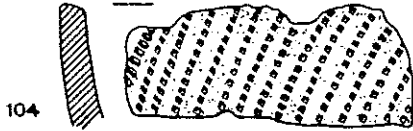
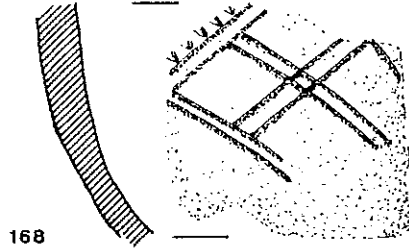
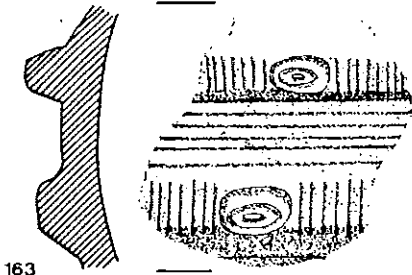

MISENGA

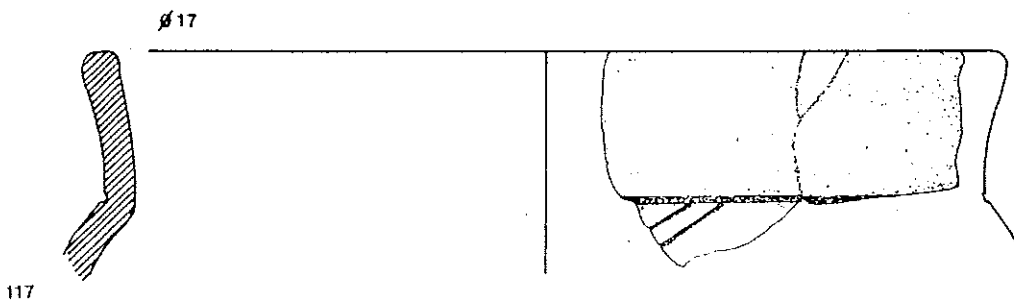
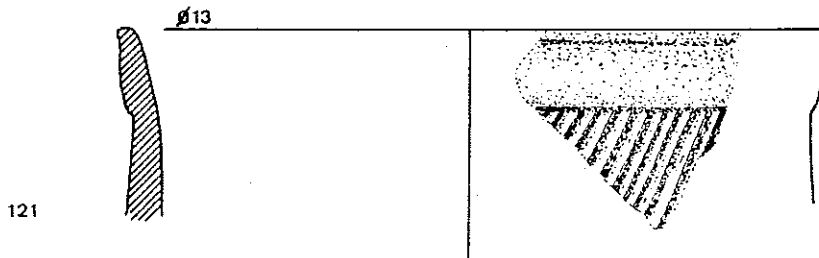
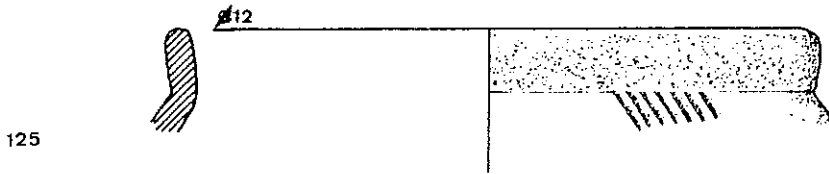

Ø24

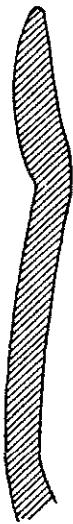

95

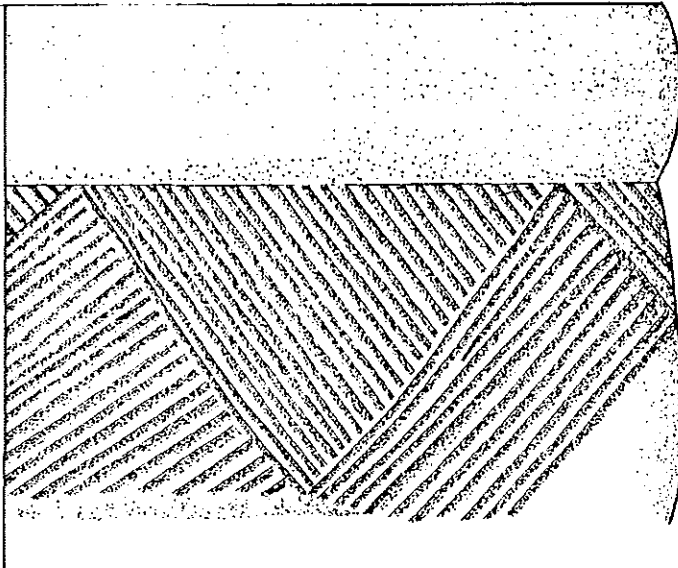

Ø11

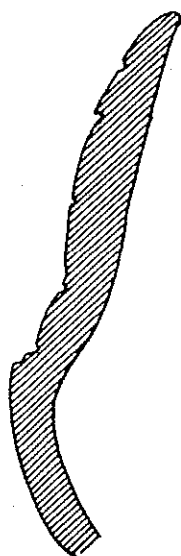

114

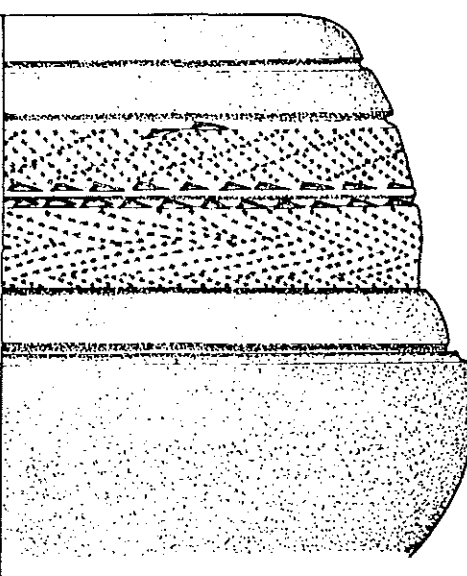

MISENGA

Ø17

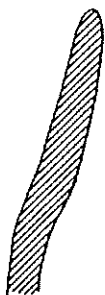

113

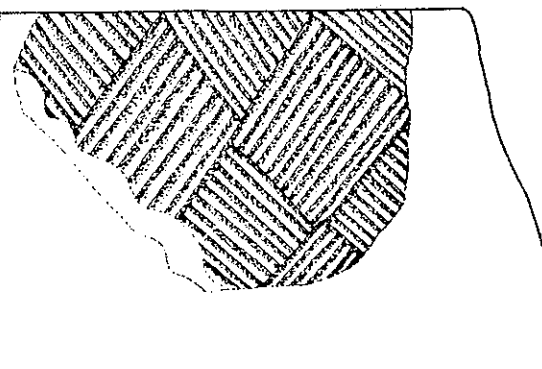

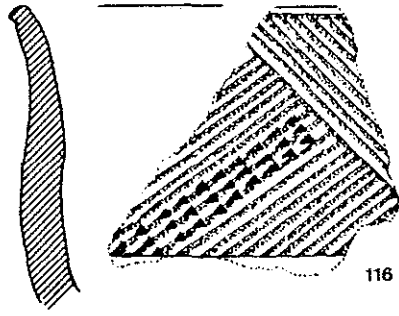

116

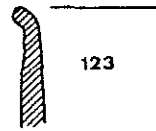

123

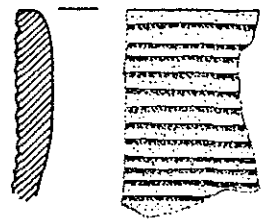

119



120

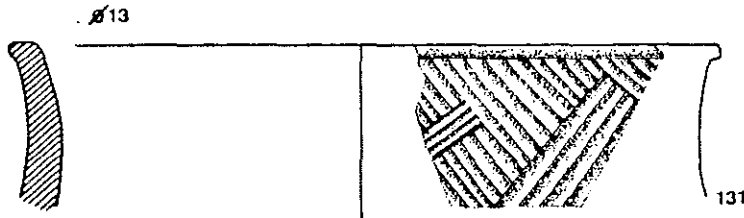

131



122

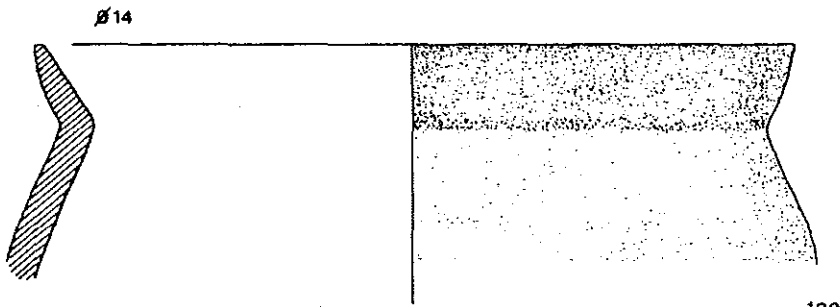

132

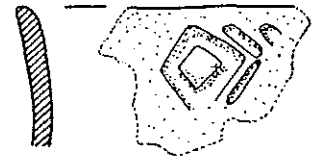

126

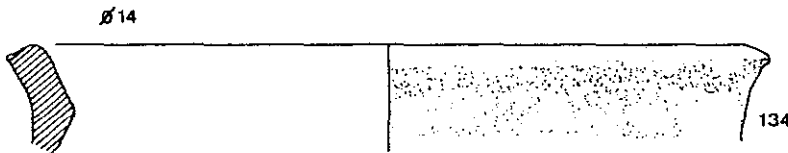

134



133

MISENGA

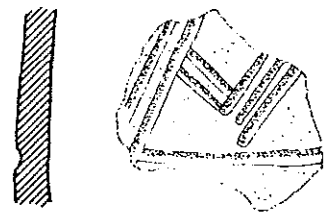

137

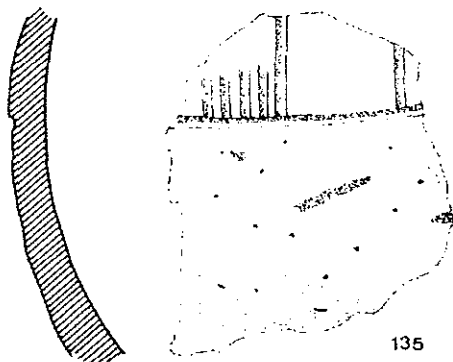

135

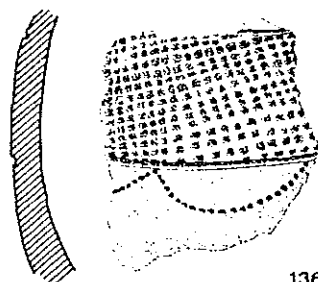

136

127



118

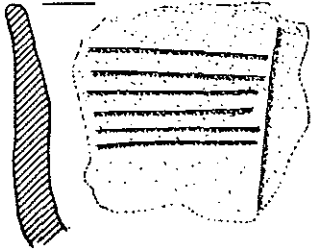

235

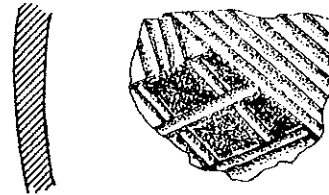

231

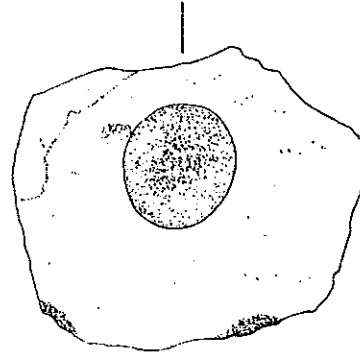

233

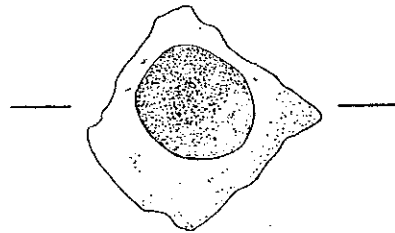

234



232

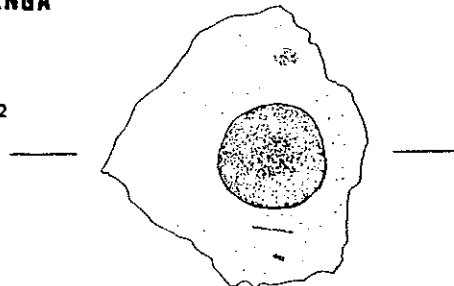

MISENGA

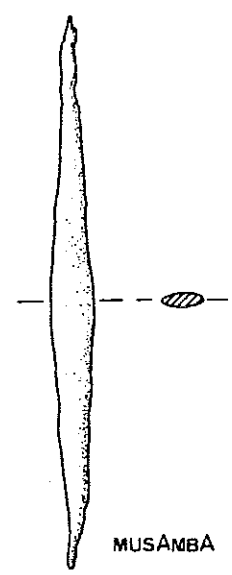
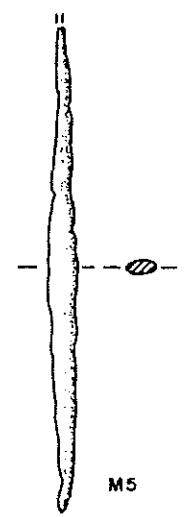
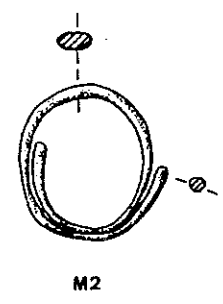
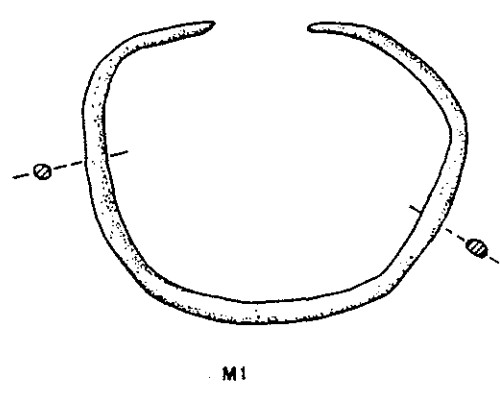

MISENGA

292

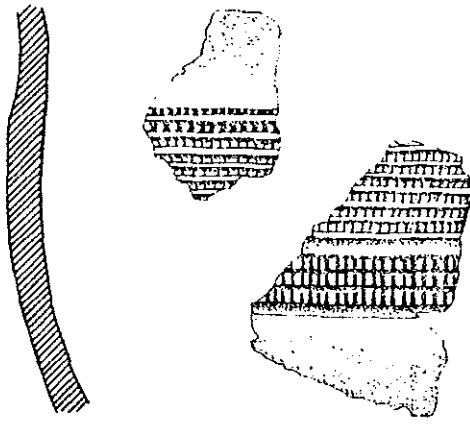

294

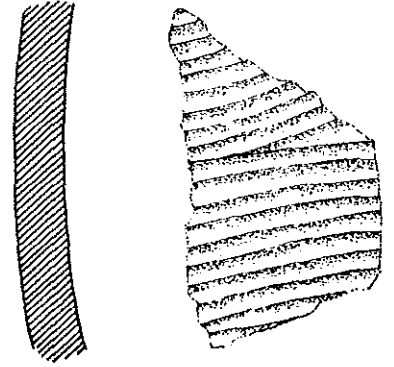

293

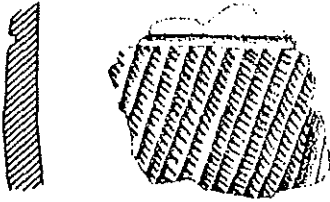

295

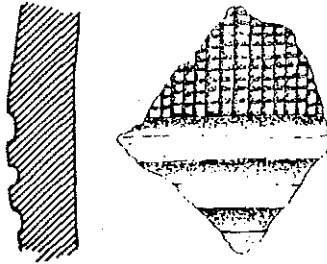

296

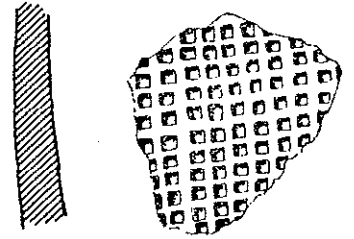

297

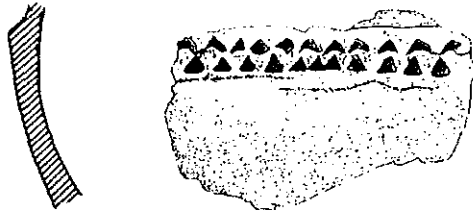

298

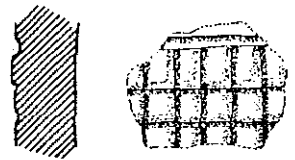

299

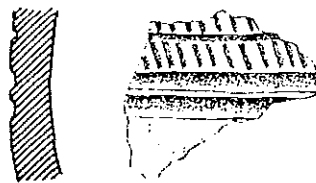

300

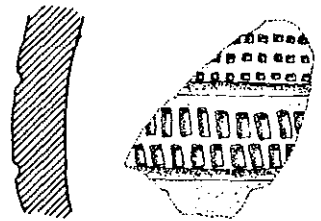

301

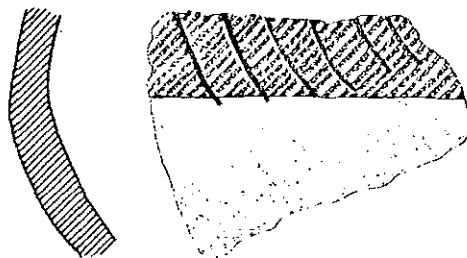

302



MANTSETSI

Ø27



266

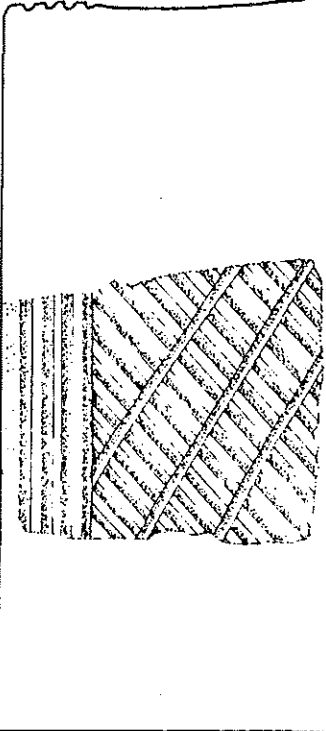

Ø28-31

MANTSETSI

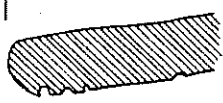

268

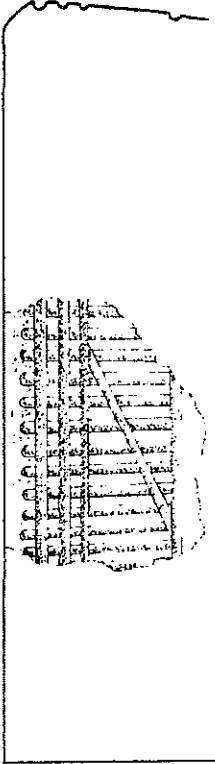

Ø28



269

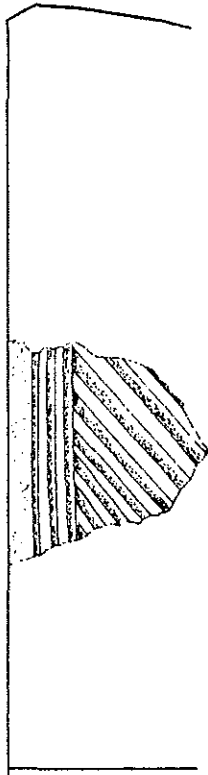

Ø15

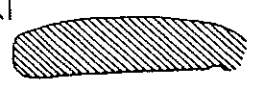

267

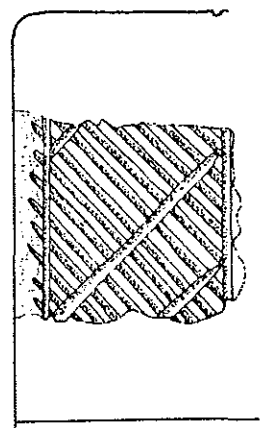

Ø21

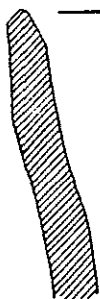

264

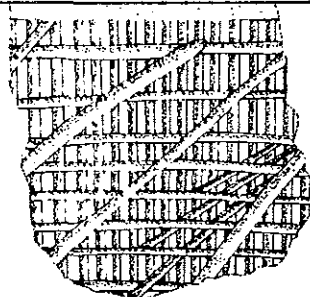

Ø20



265

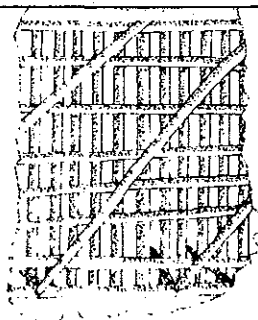

Ø15



273

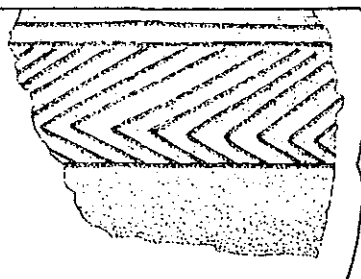

Ø14

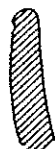

274



275



276



MANTSETSI

272



270

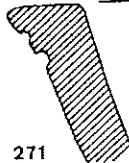

271

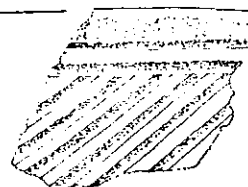

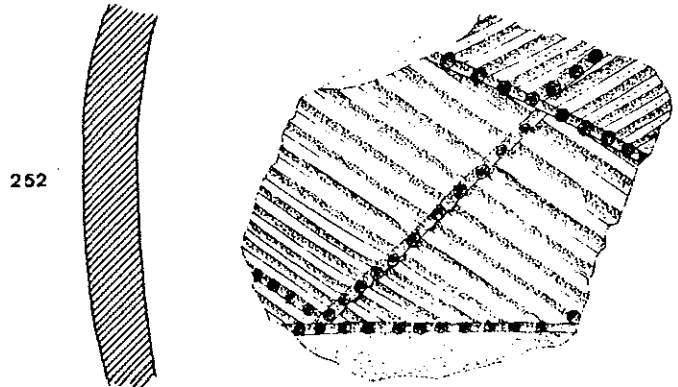
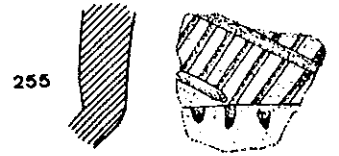
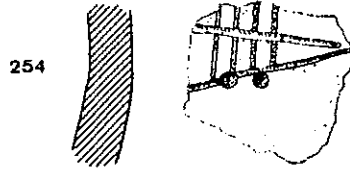
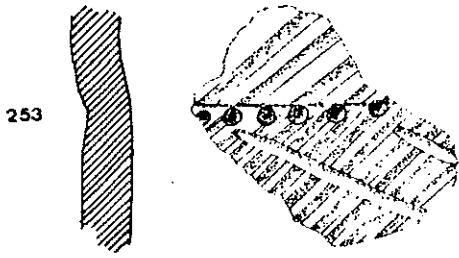

MANTSETSI

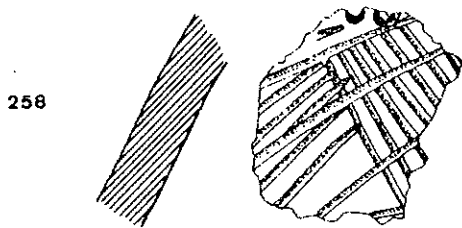
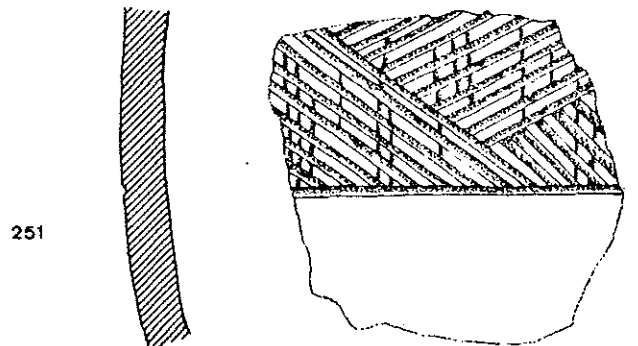
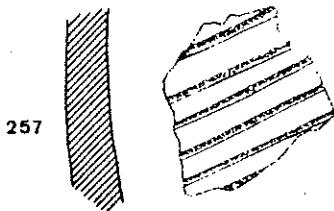

3,4



260

$\varnothing 9$

MANTSETSI ET KINKENGE (306)

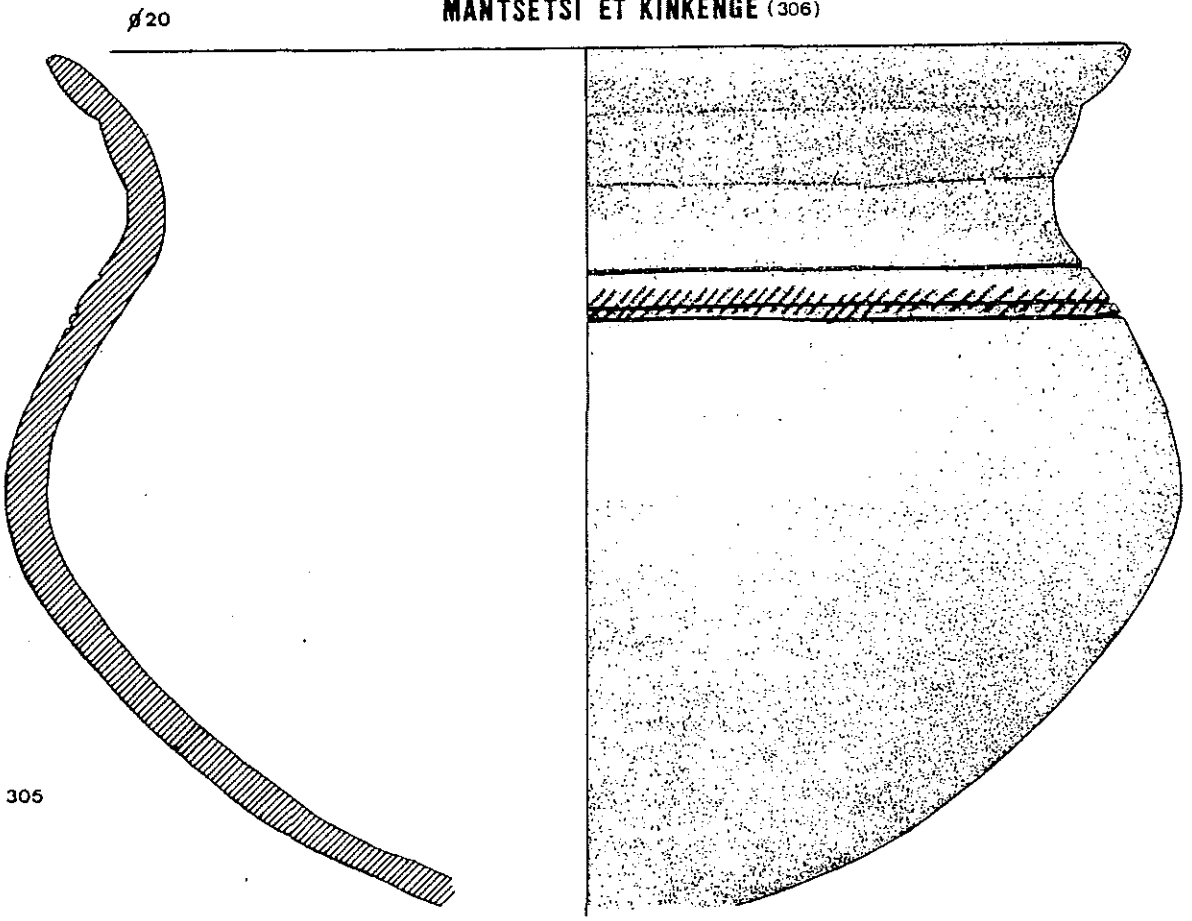

$\varnothing 20$

305

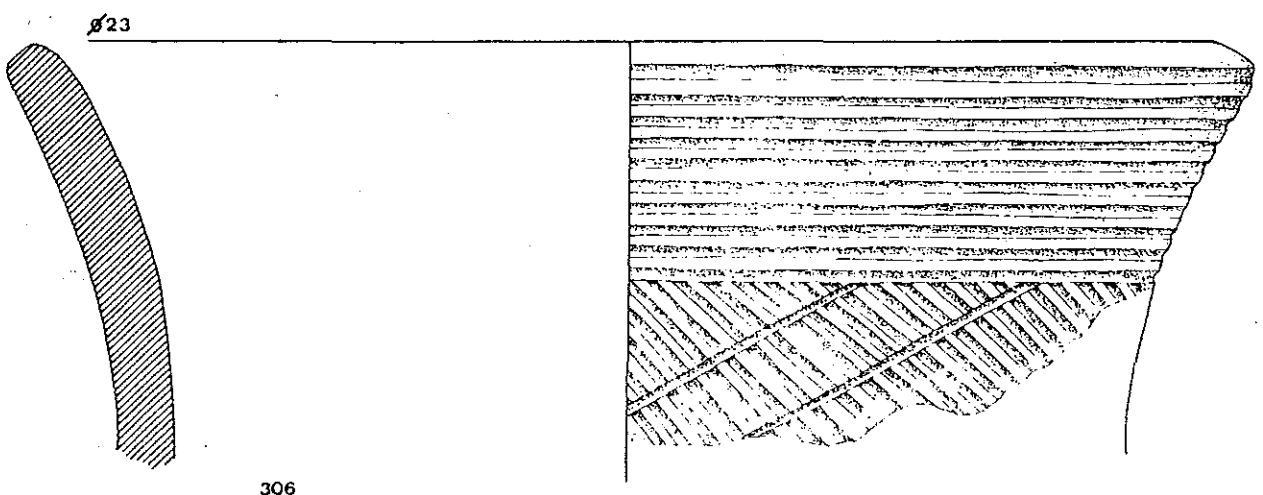

$\varnothing 23$

306

Ø23



322

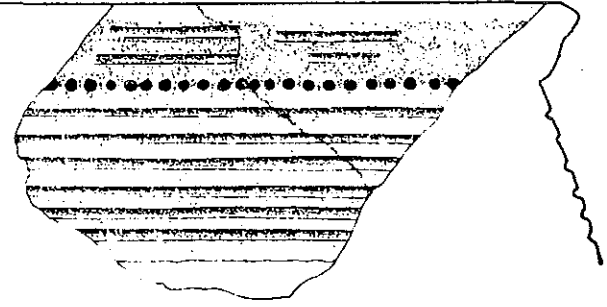

Ø19



323

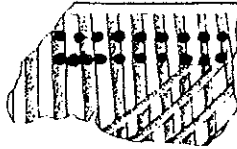

318

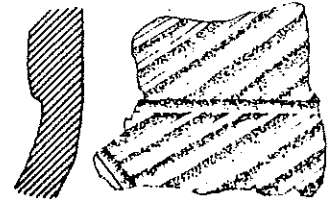

307

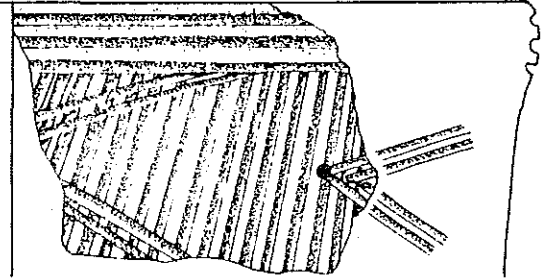
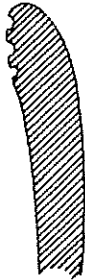

Ø16

314

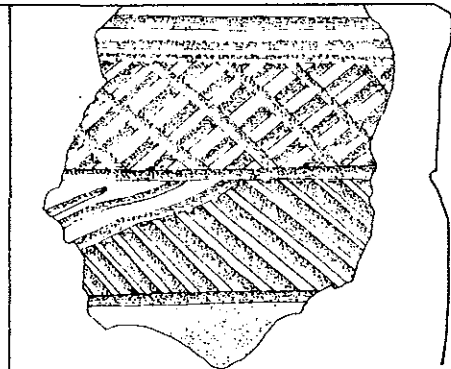

309

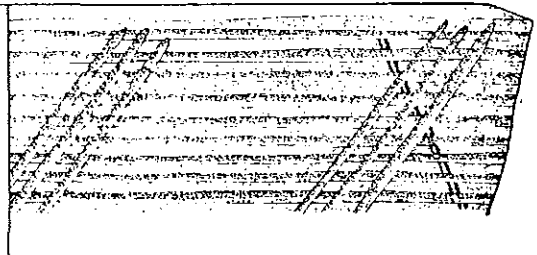
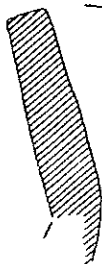

Ø18



ø+40

312

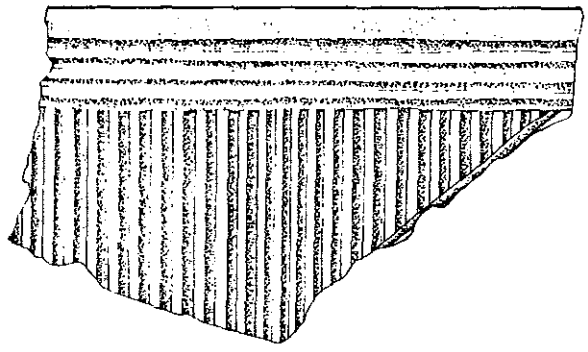
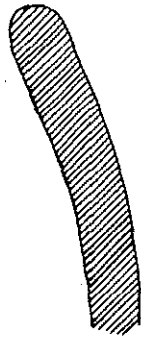

ø27

316

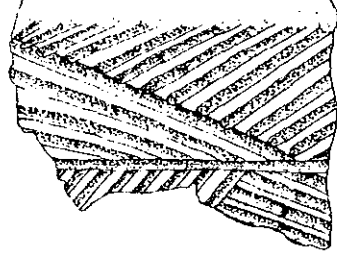
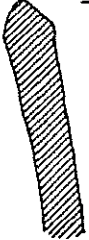

ø36

313

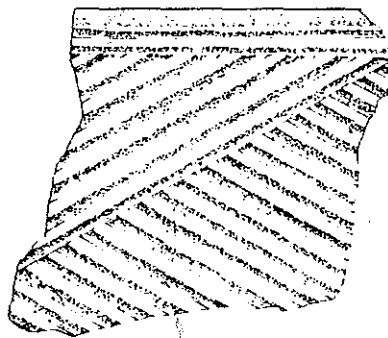

315

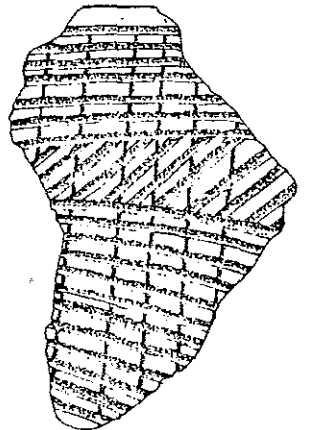

KINDU II



346



ø83

345

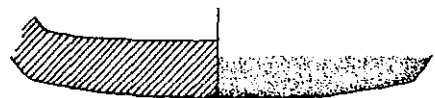

ø7

ø18

352

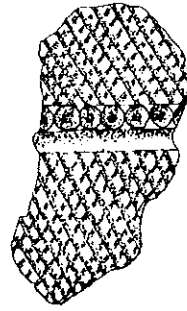
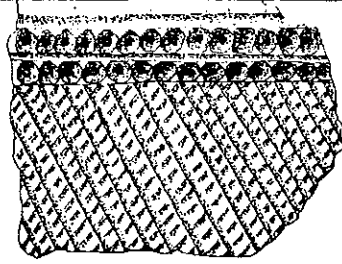

ø17

353

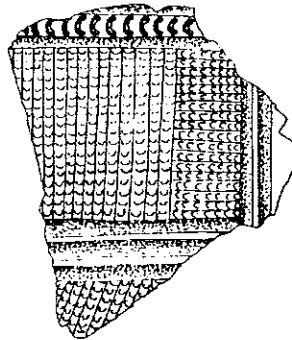
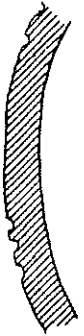
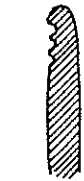

KINDU II

349

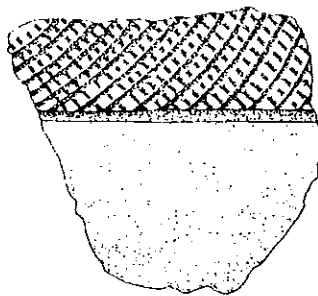
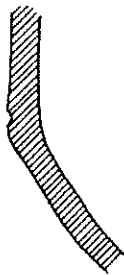

ø 20

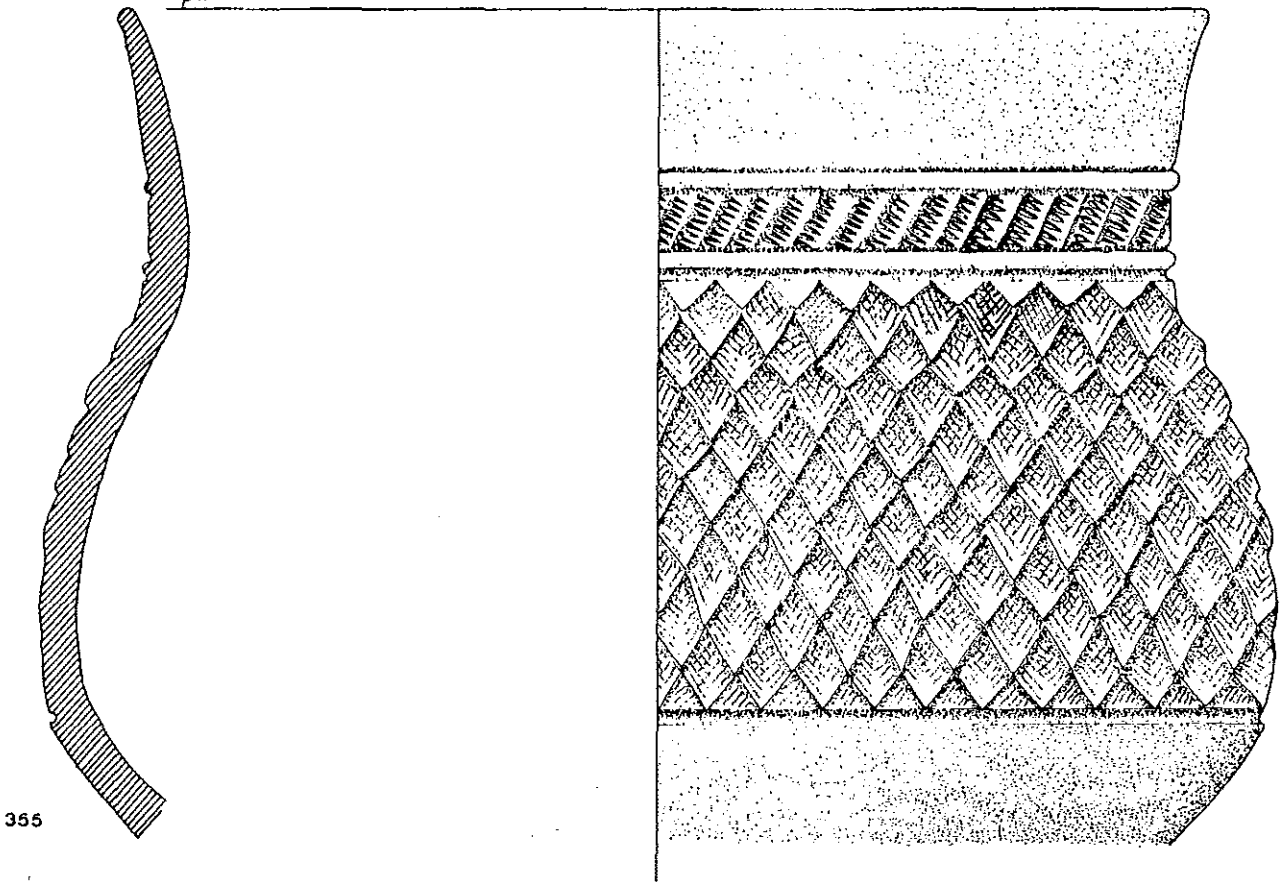

SUMBI

ø 20

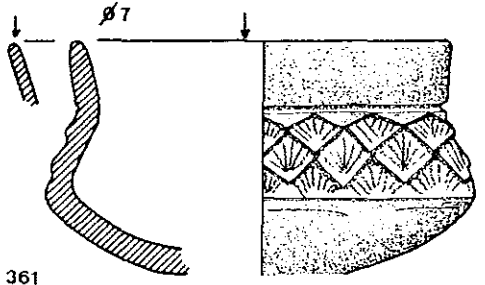
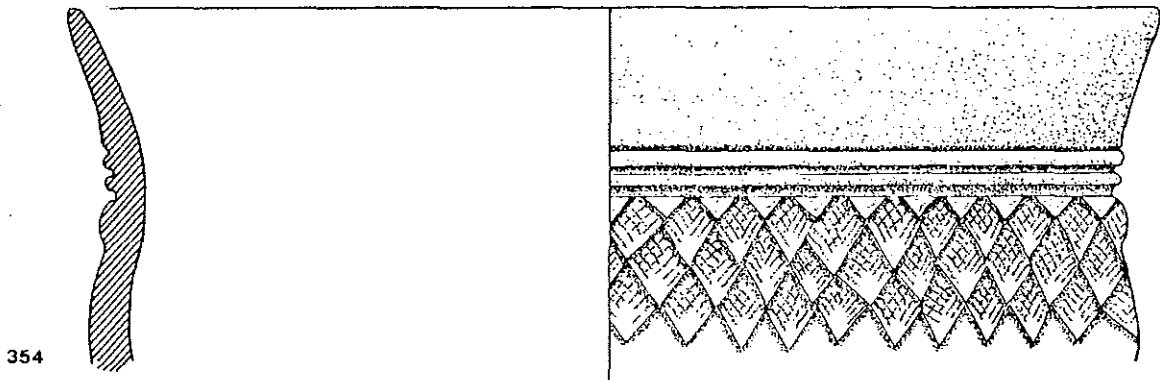

ø 13

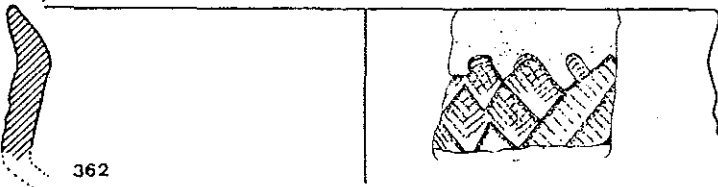

ø 16

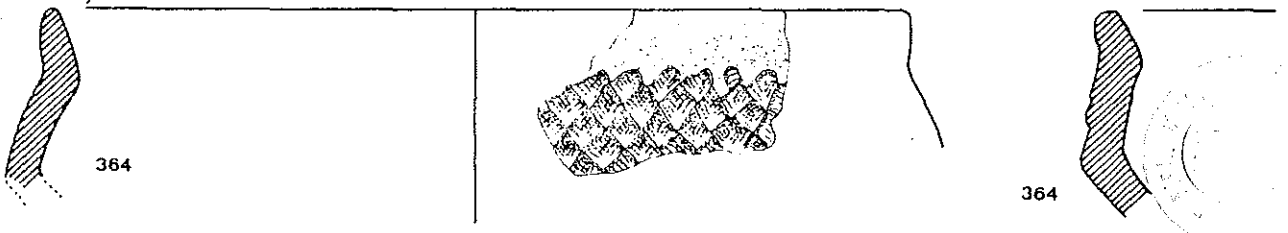

φ19

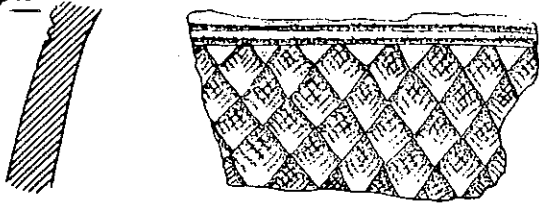

365

φ22

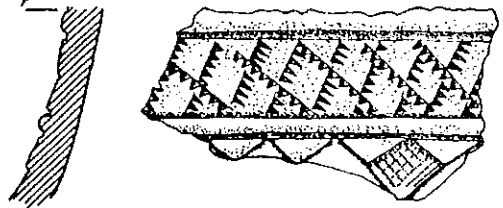

366

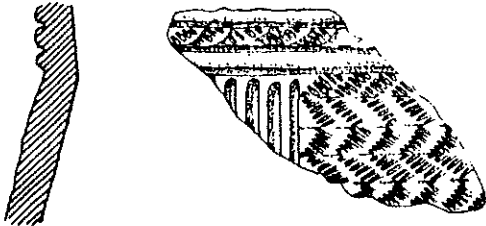

367

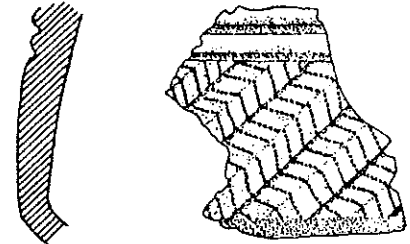

368

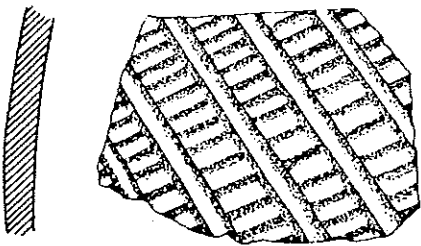

374

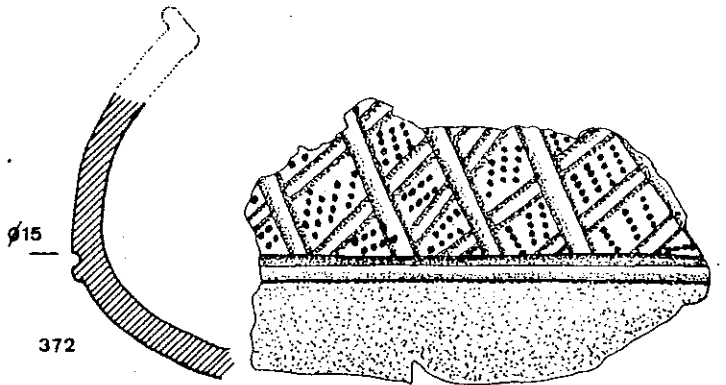

372

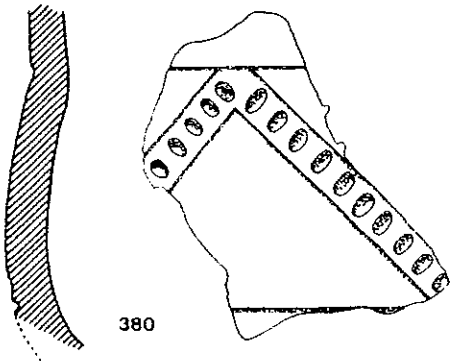

380

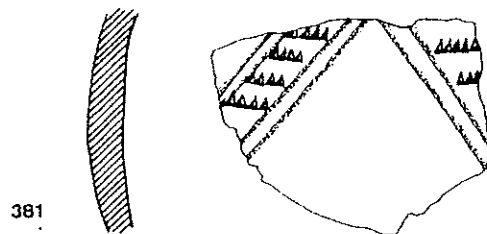
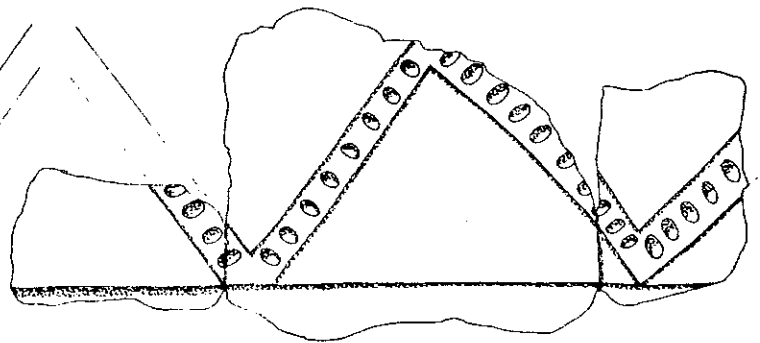

381

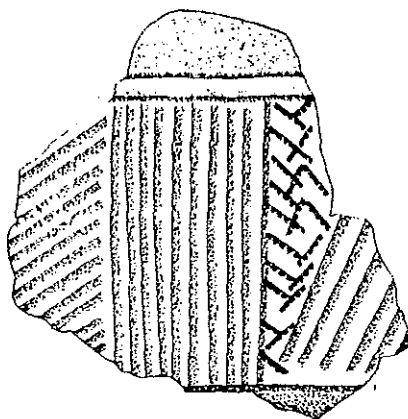
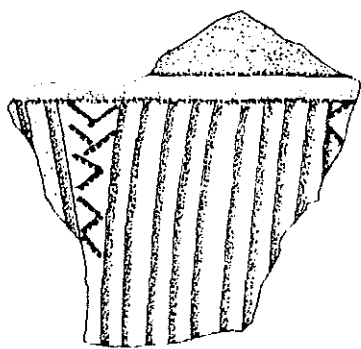
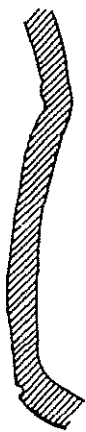

379

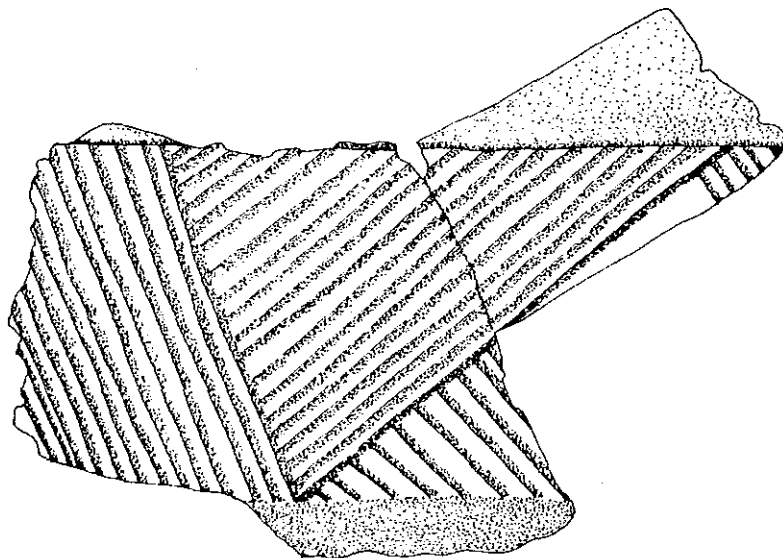
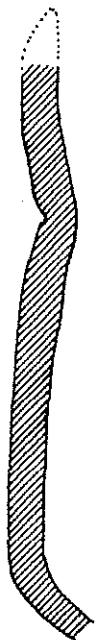

378

∅ 15



382

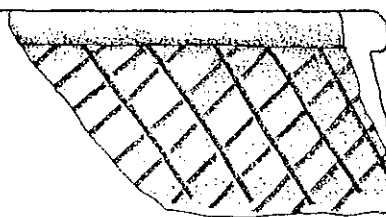

∅ 25 ±

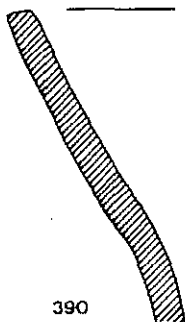

390

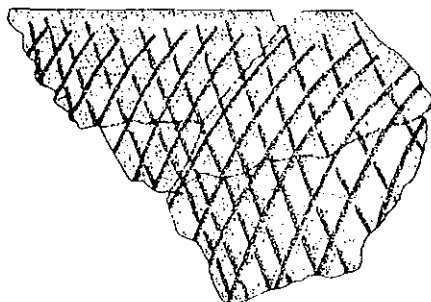

383

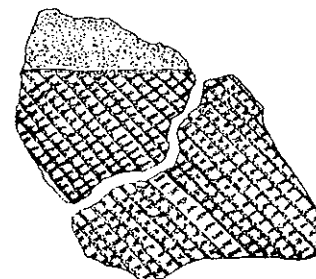

391

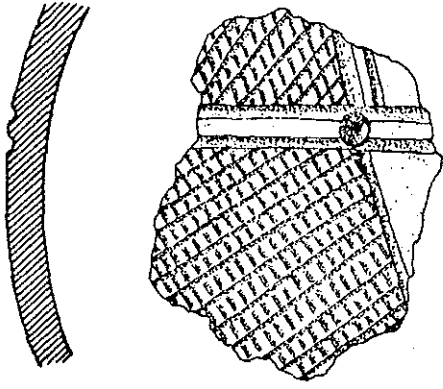

388

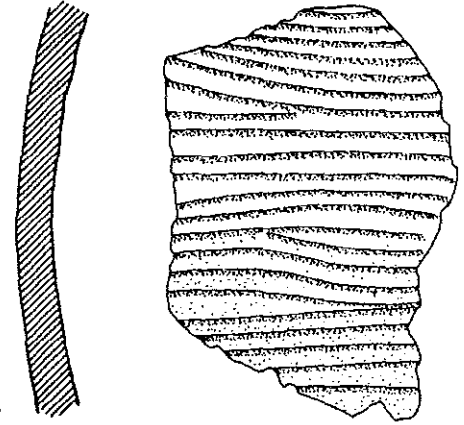

377

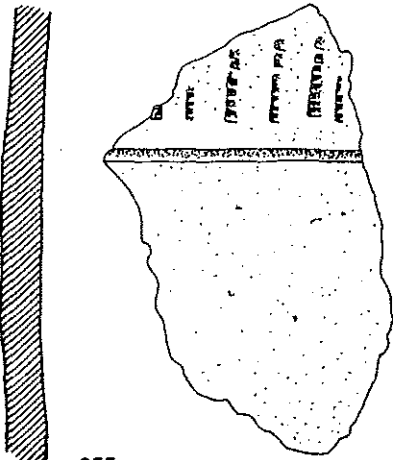

376

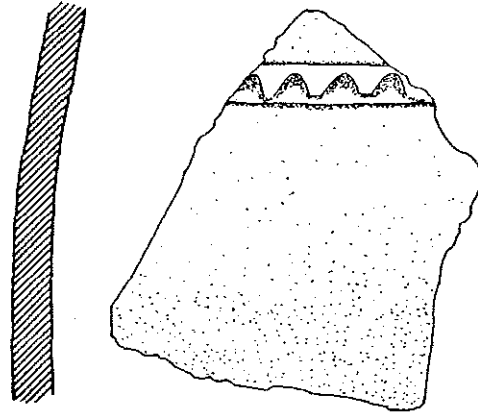

1:30

384

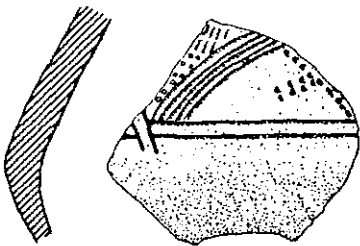

489

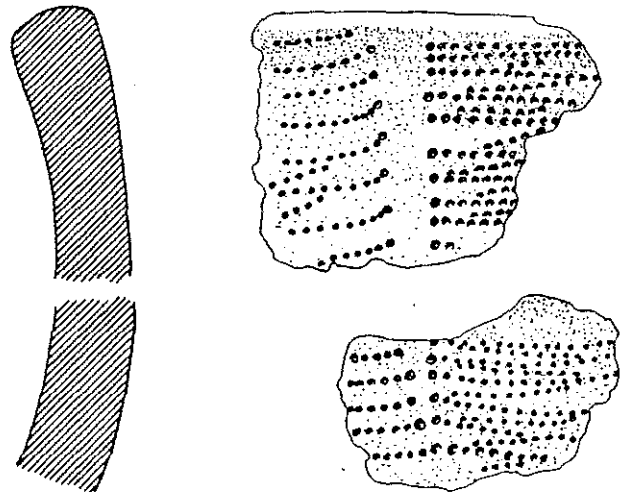

ø 19

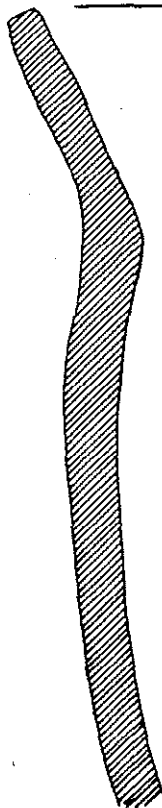

483

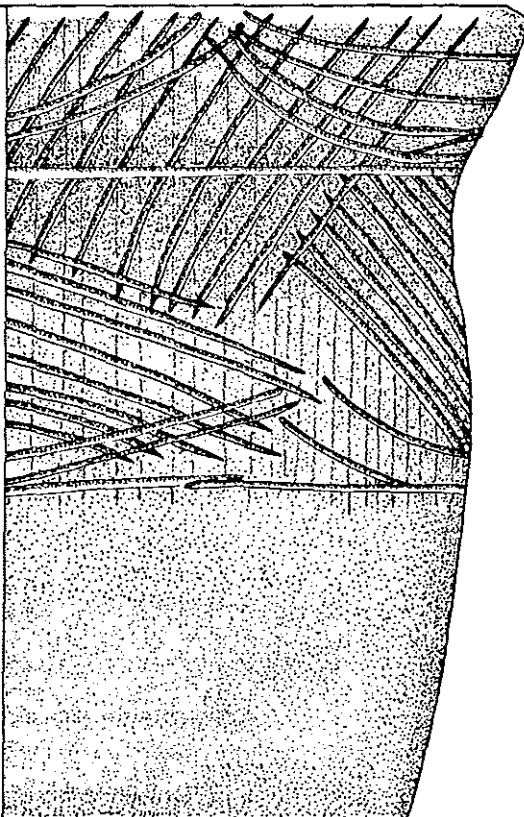

ø 12



484

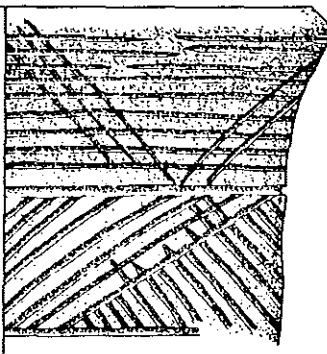

SUMBI

ø 17

485

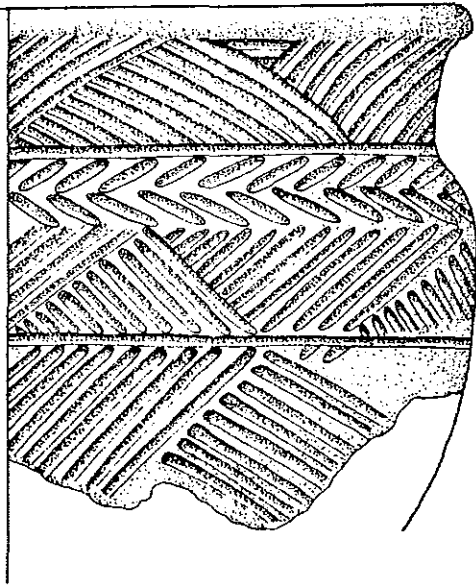
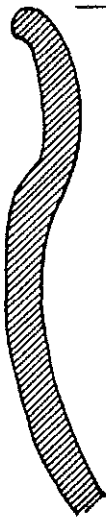

ø 19

486

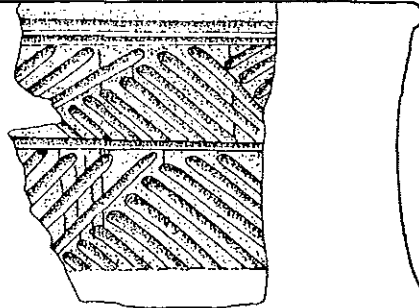

ø 16

487

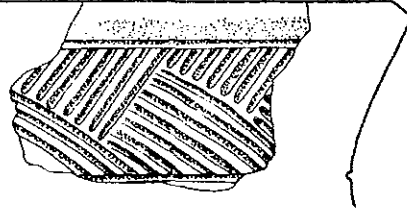
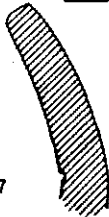

ø 21

488

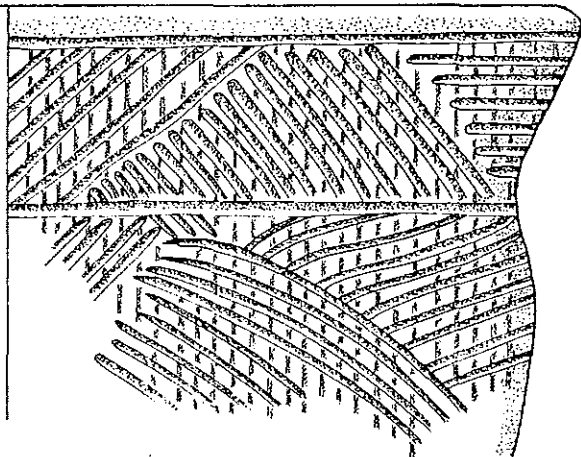
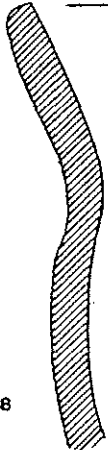

ø 24

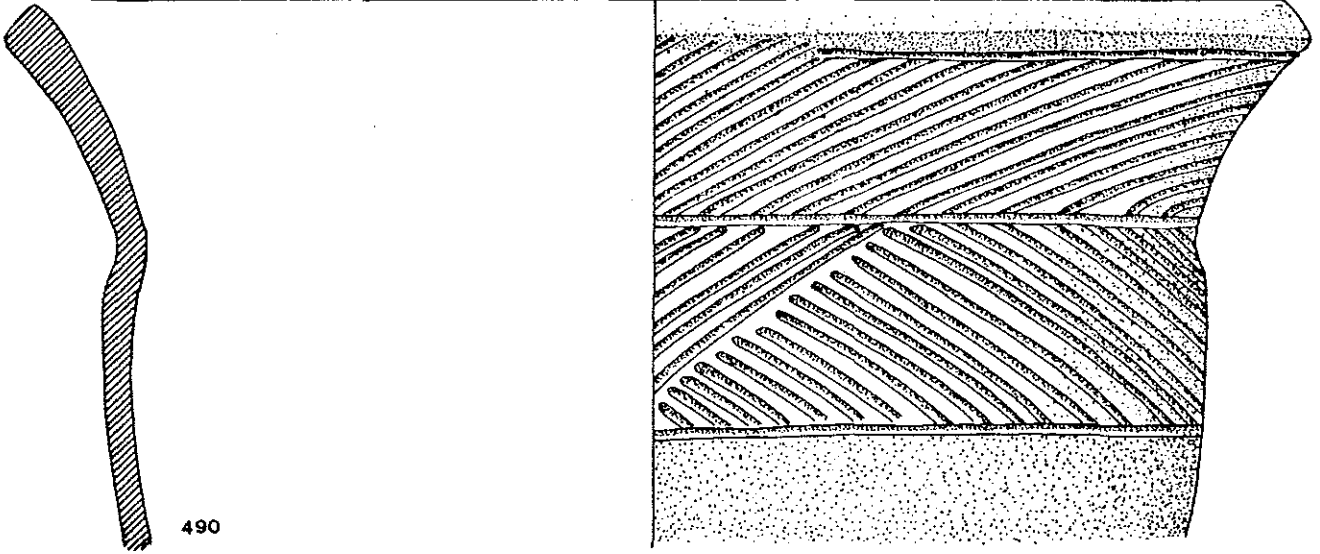

ø 23

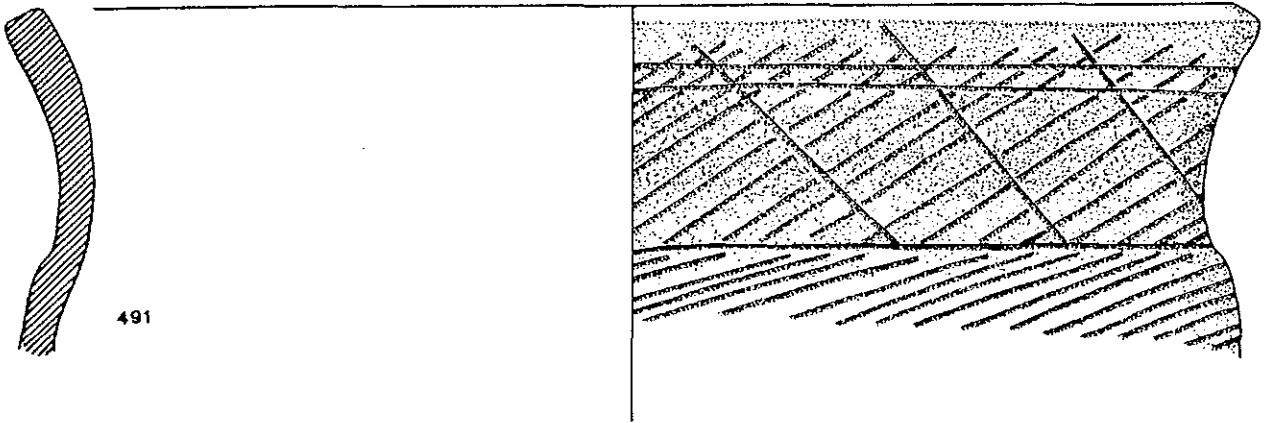

ø 13

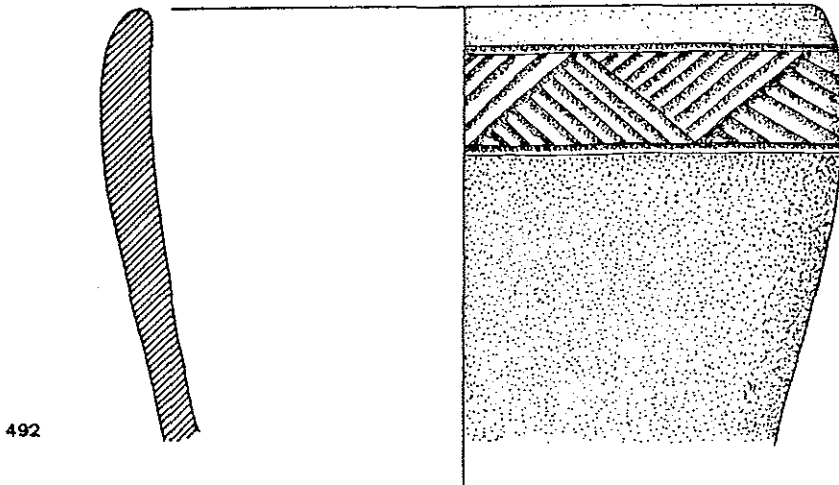

SUMBI

ø 33

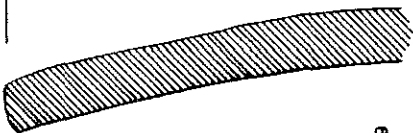

569

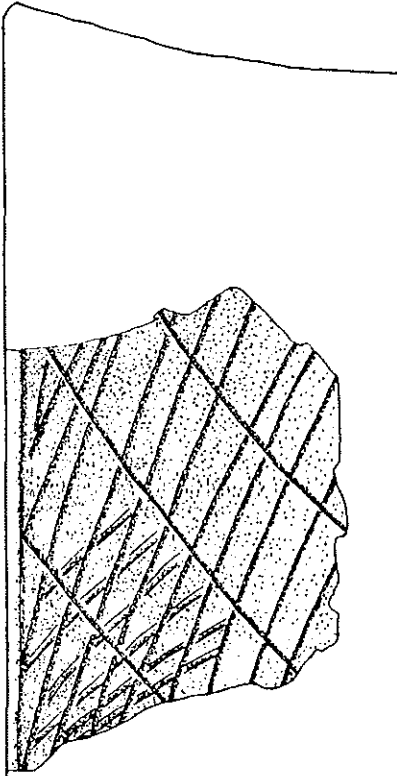

ø 29

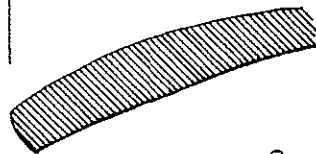

570

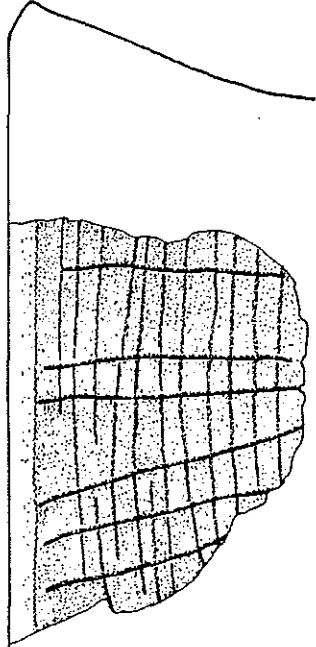

g22

566

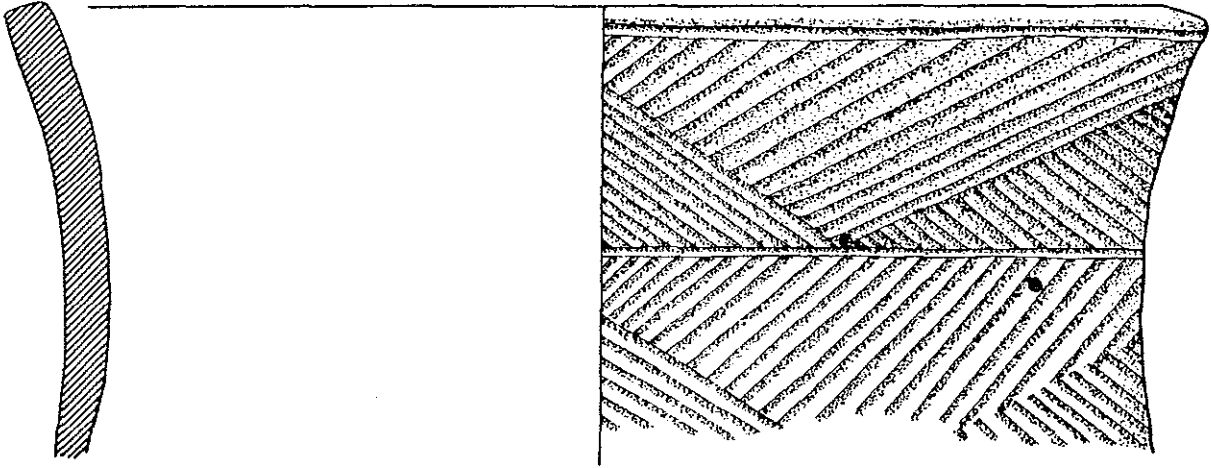

567

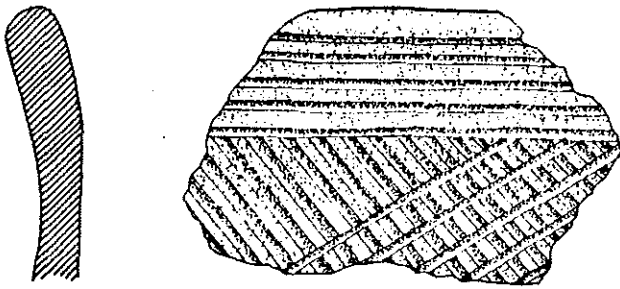

g18

565

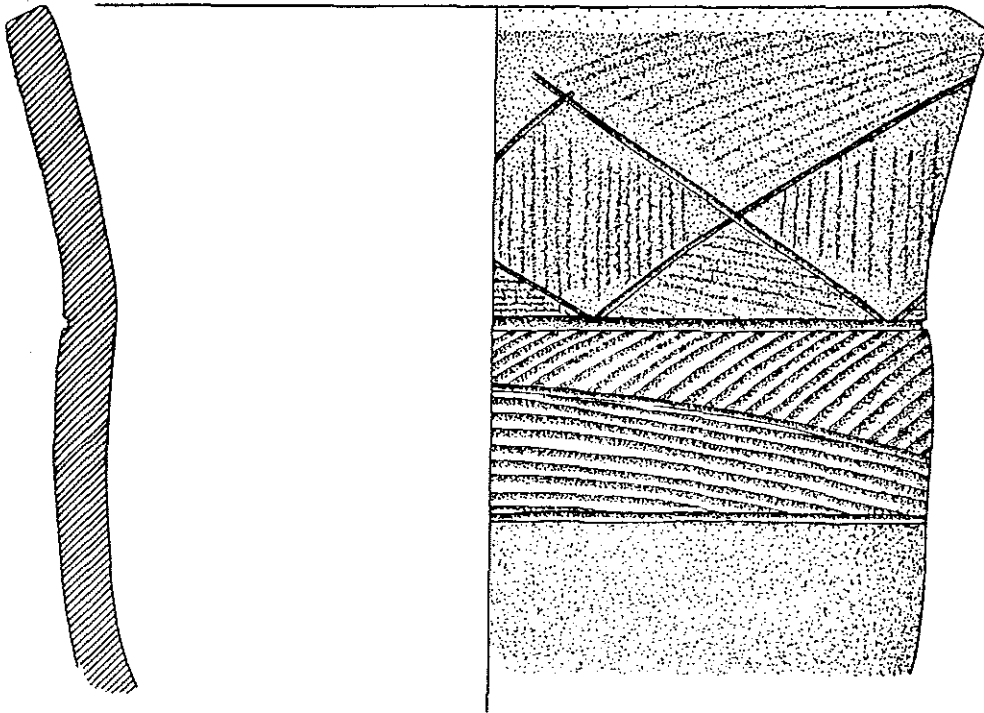

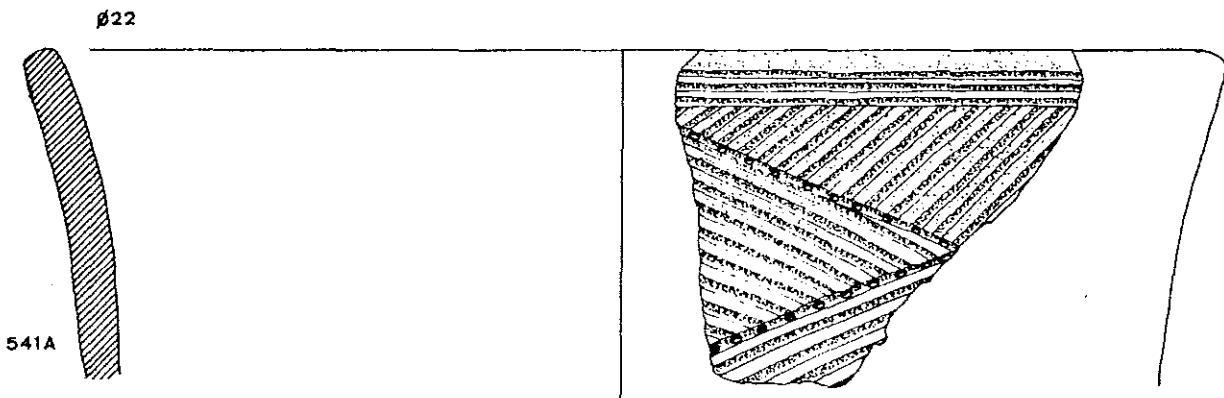
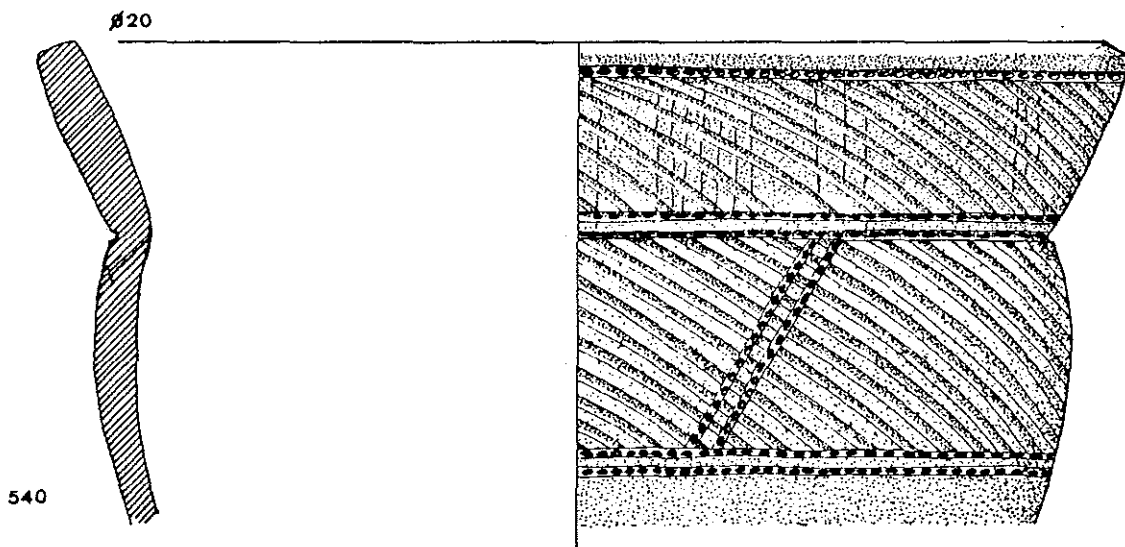
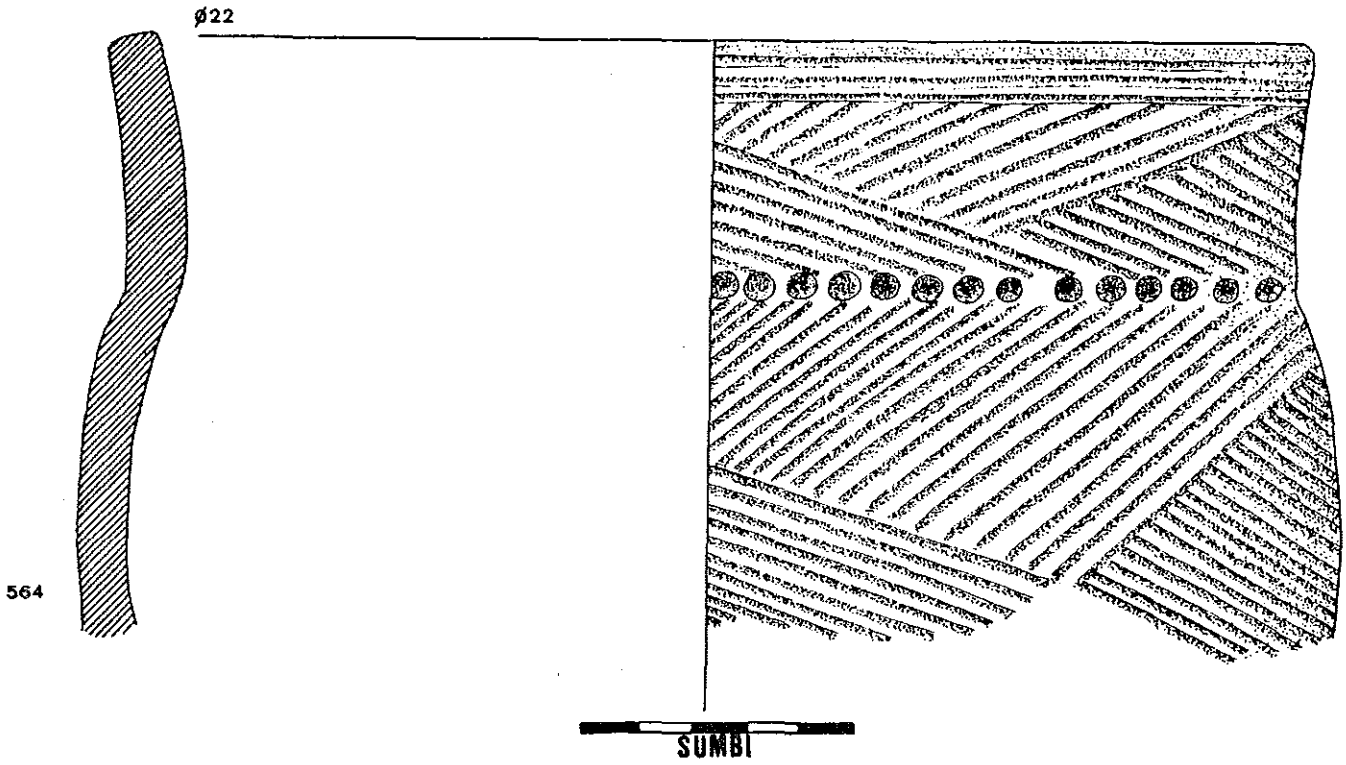

ø 17

501

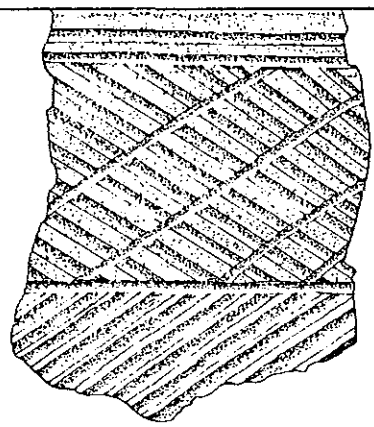

ø 16

502

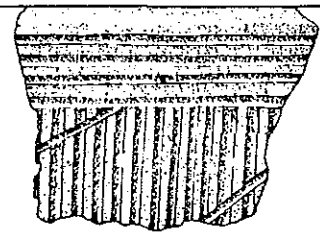
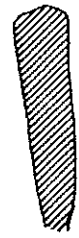

ø 16

504

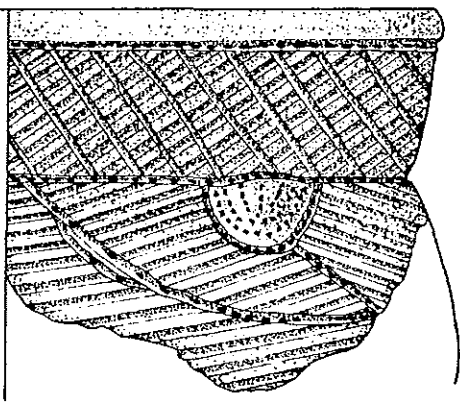

ø 20

505

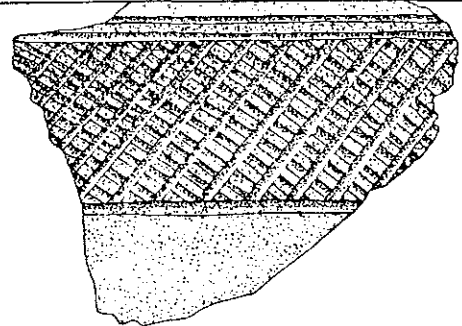
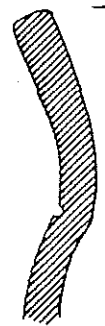

ø 22

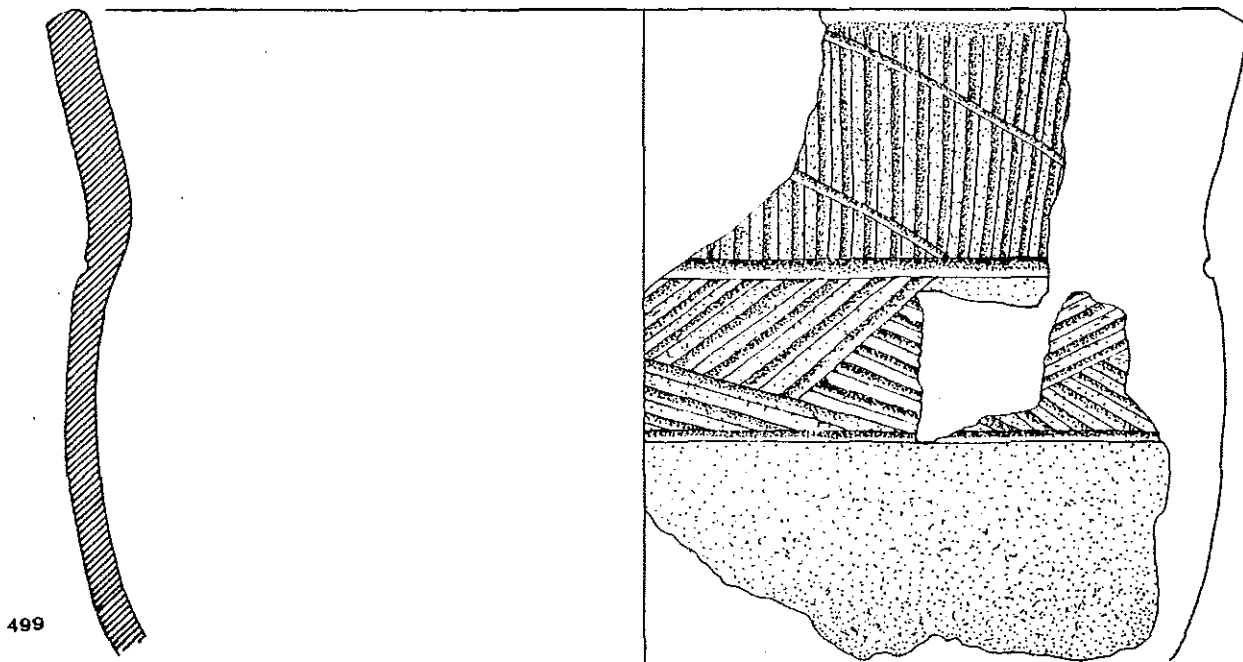

ø 22

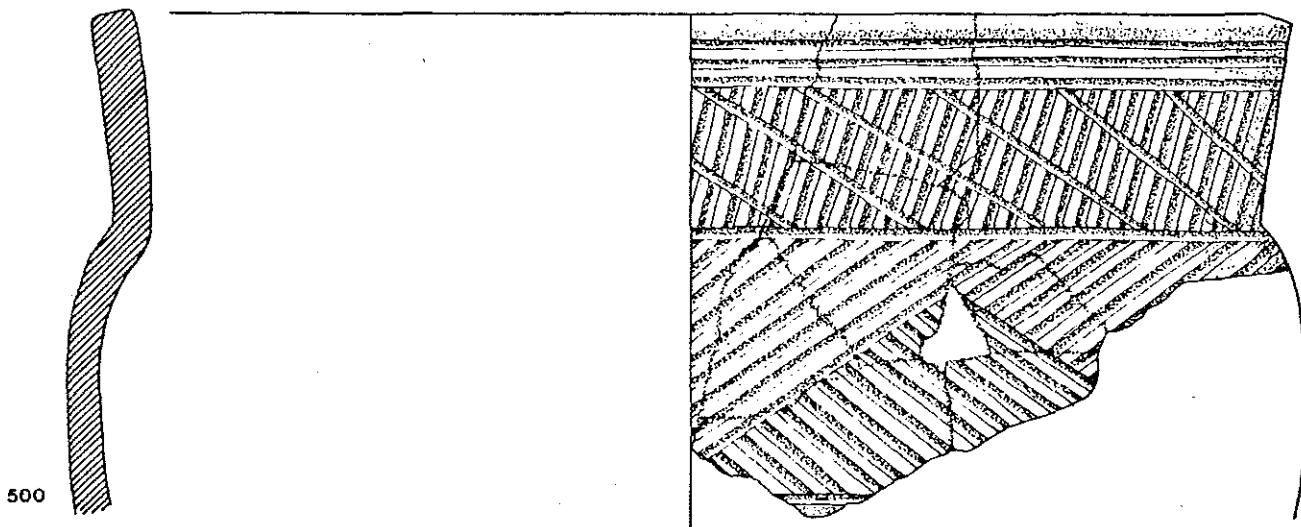

SUMBI

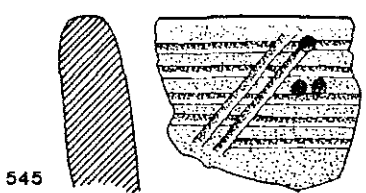
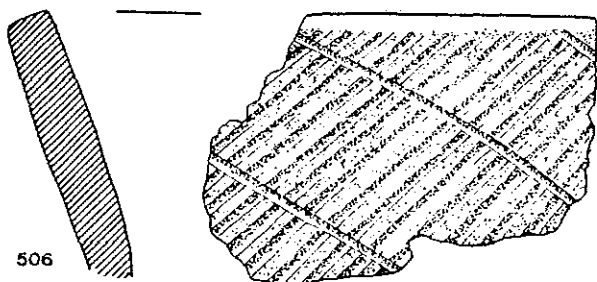

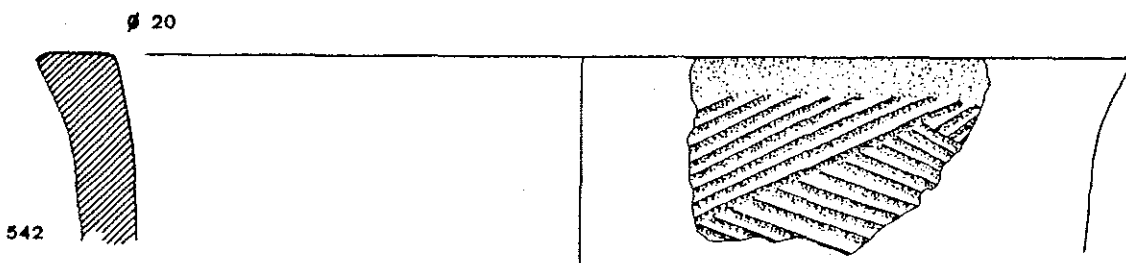
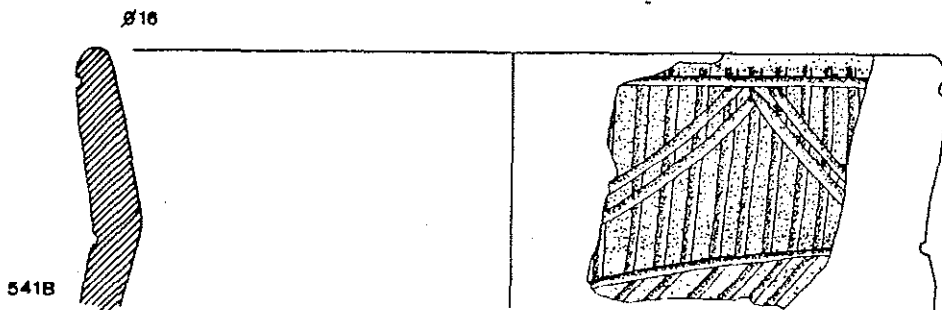
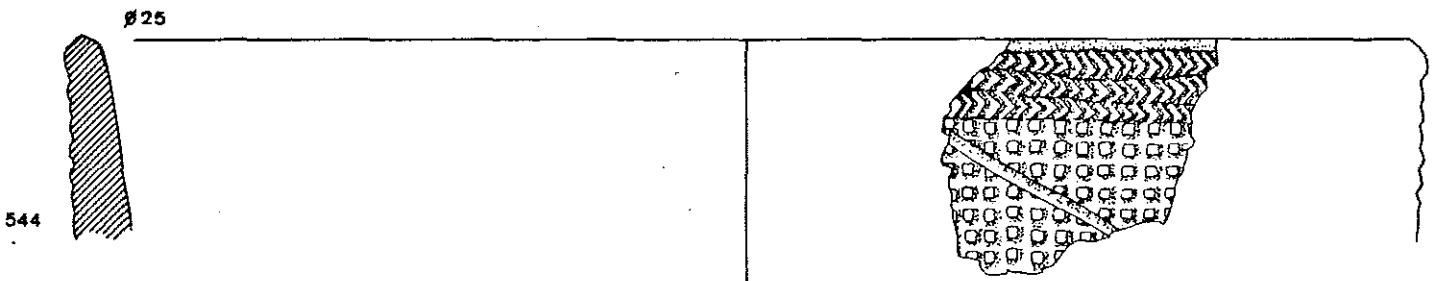
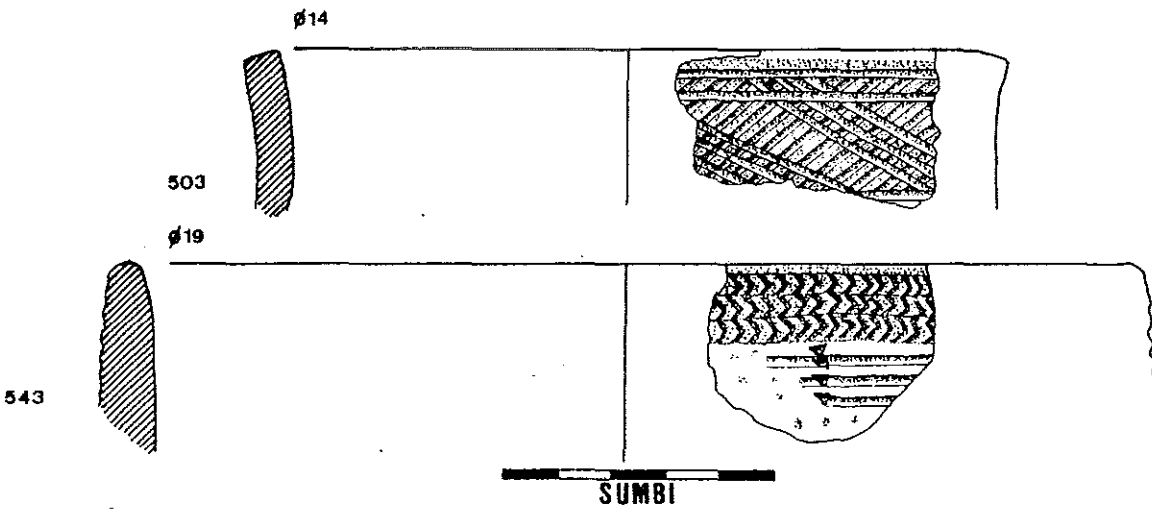
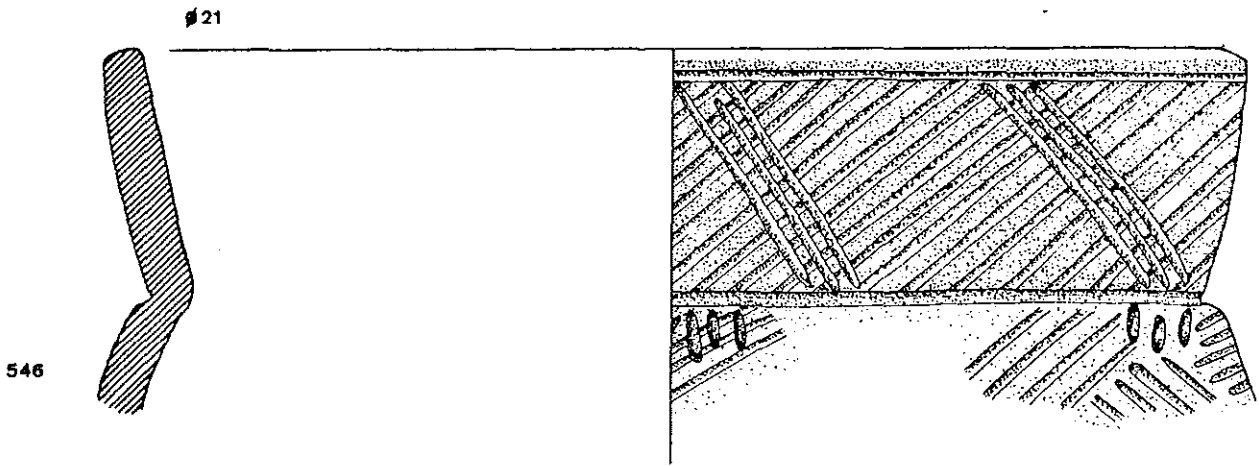

ø19

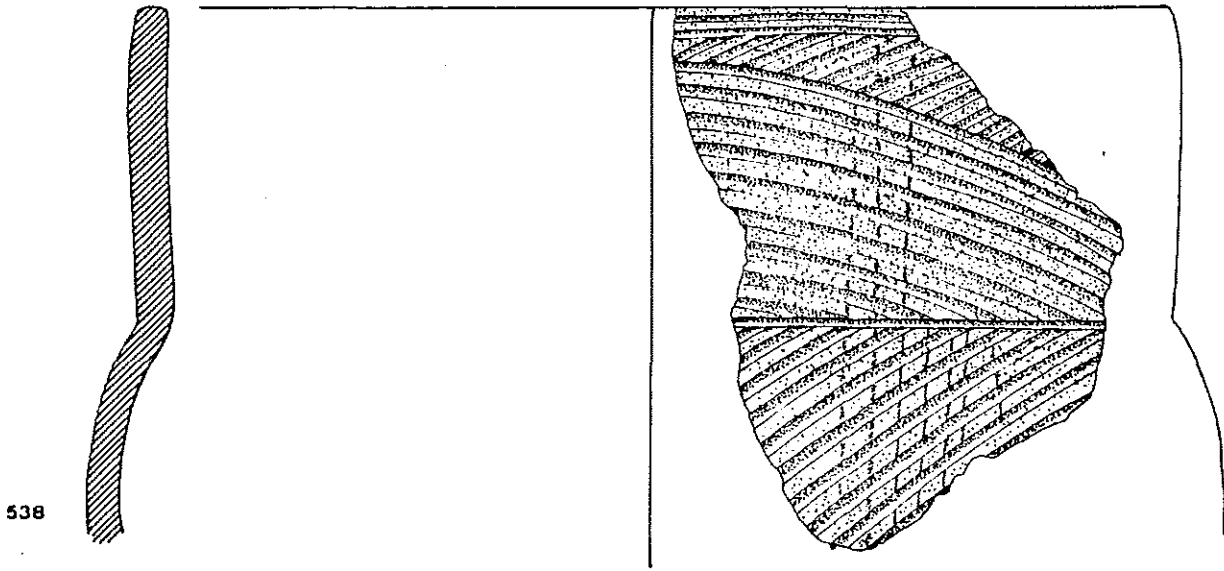

ø13

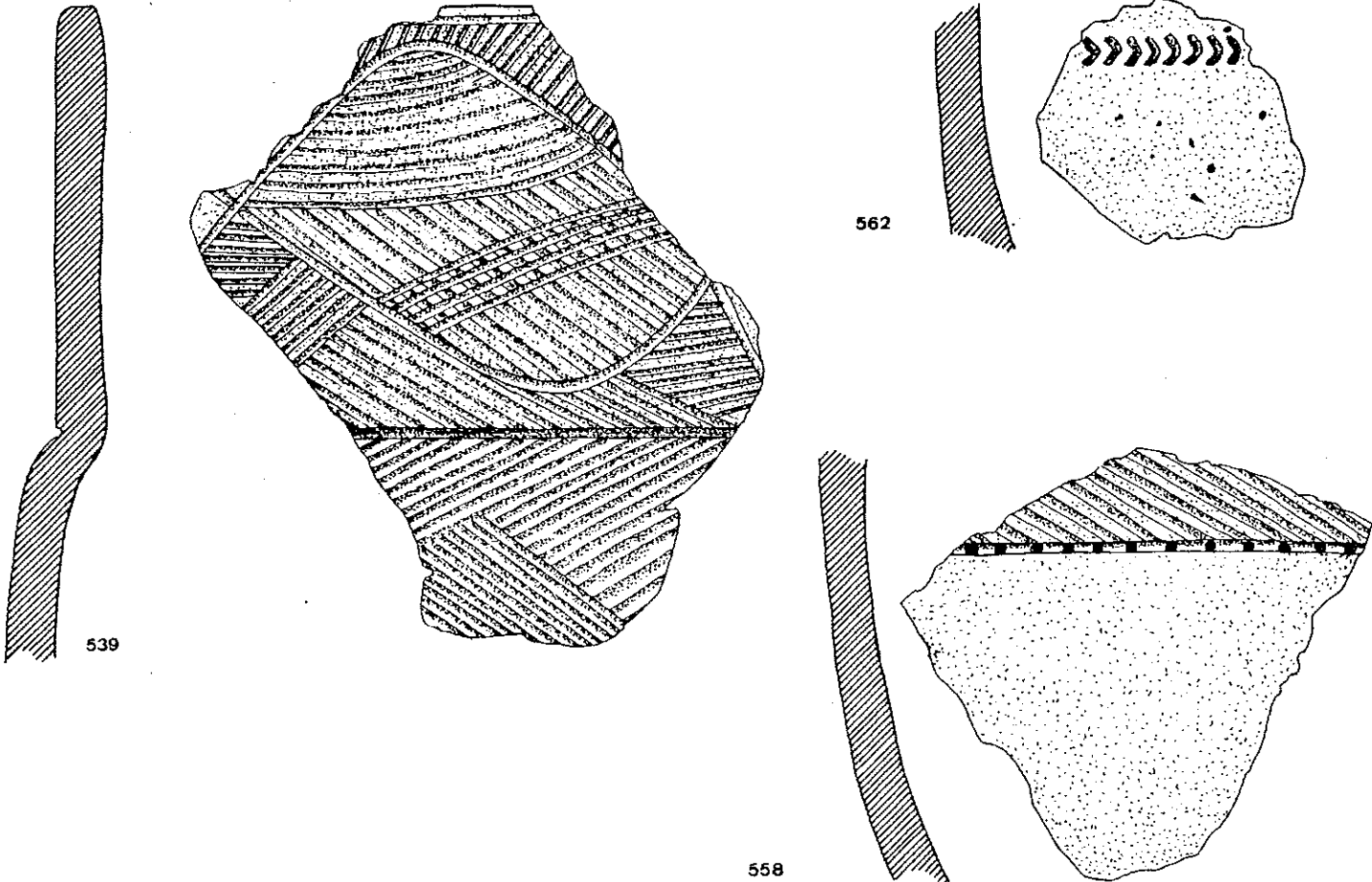
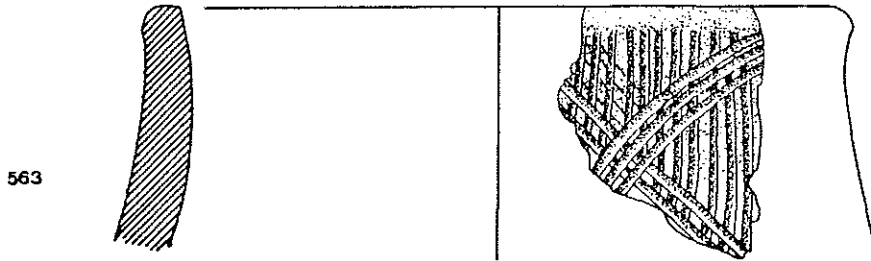

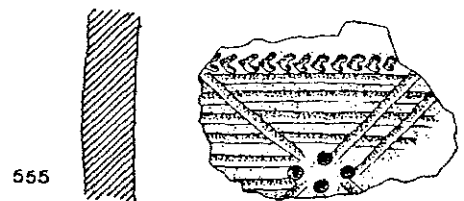
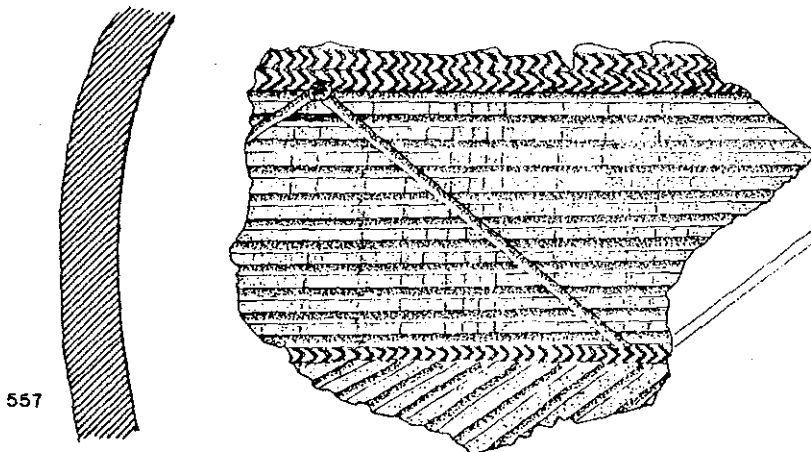
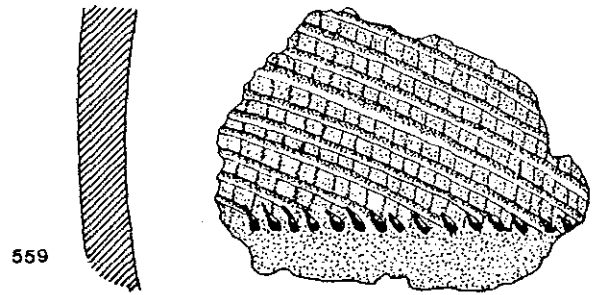
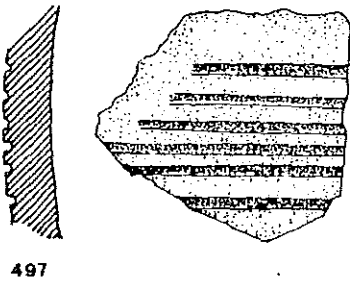
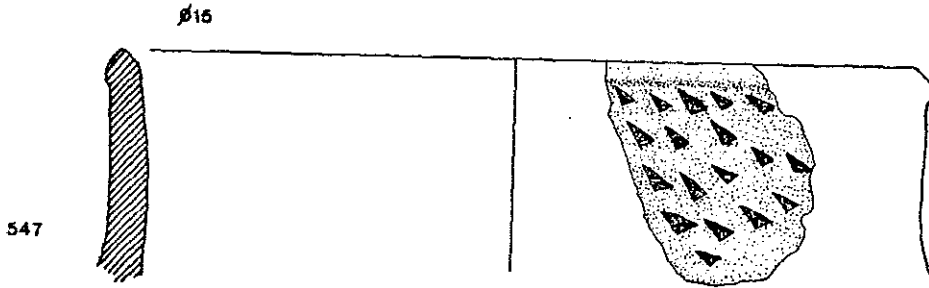
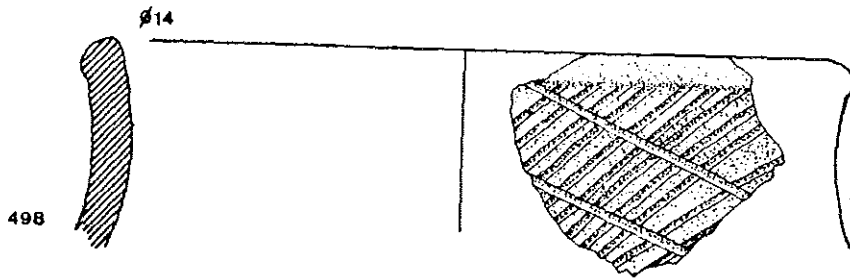

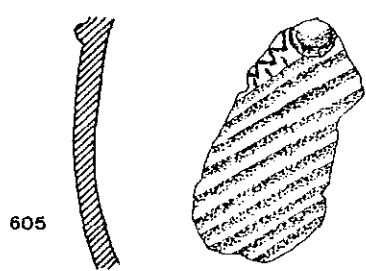
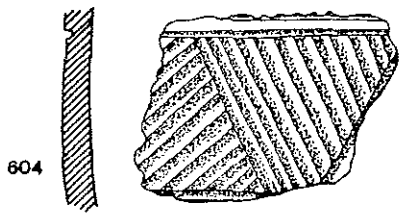
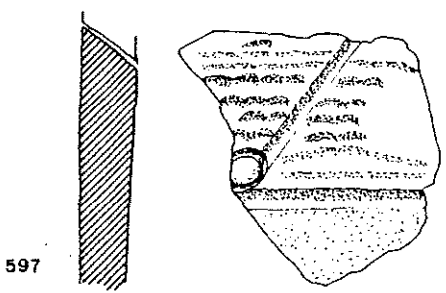
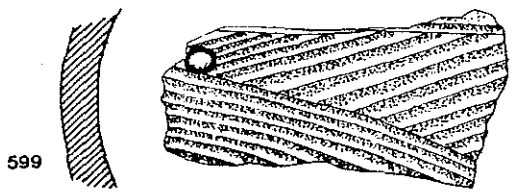
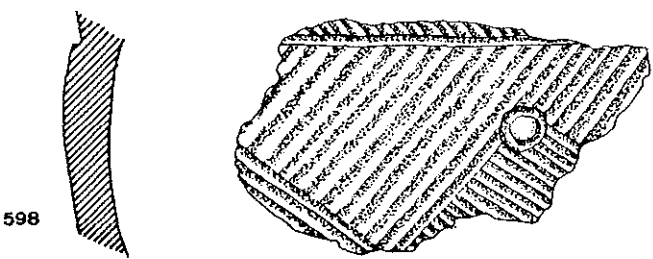
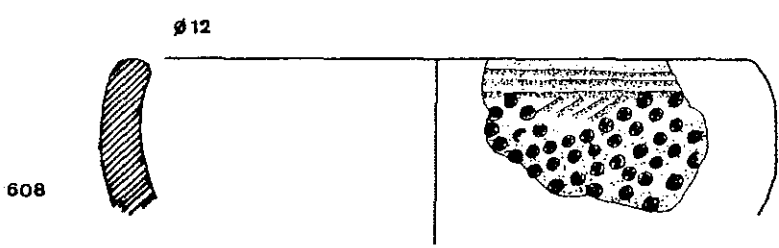
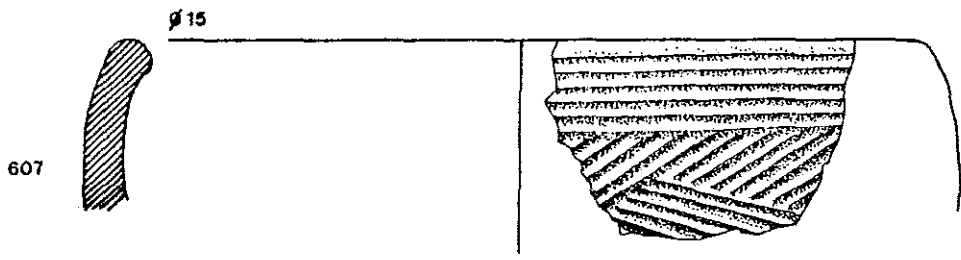

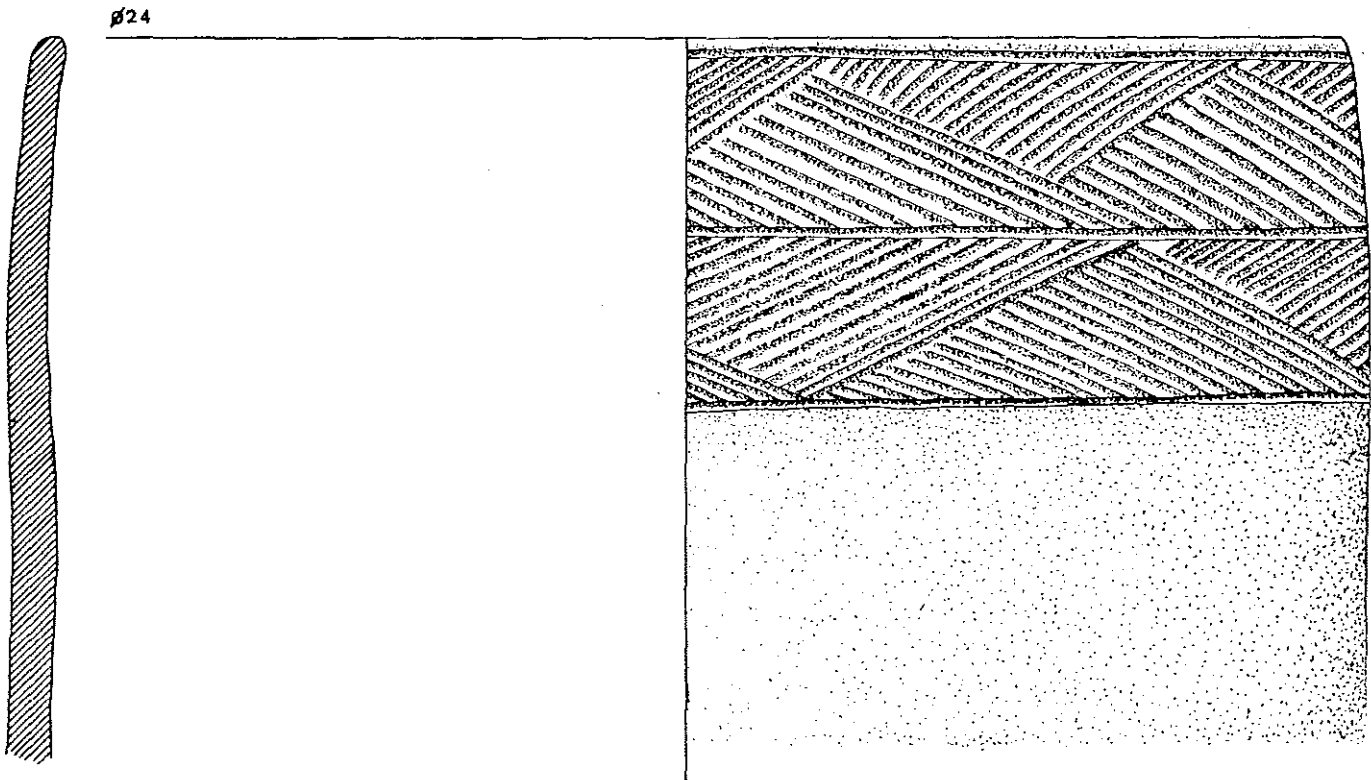
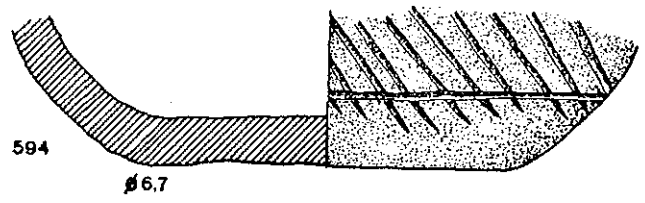
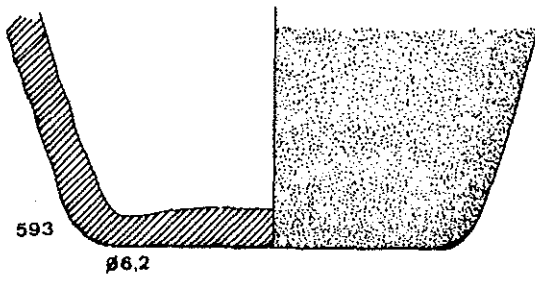
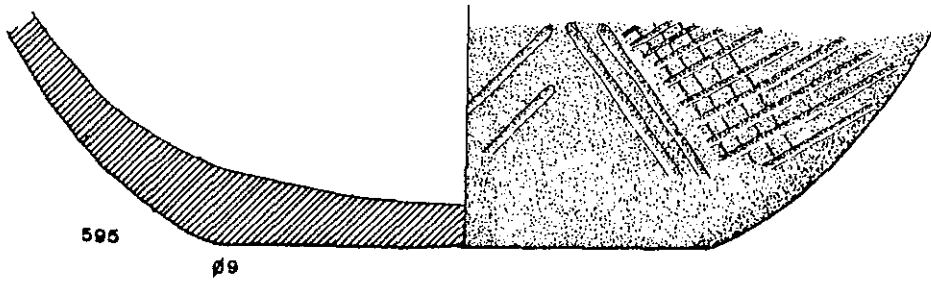
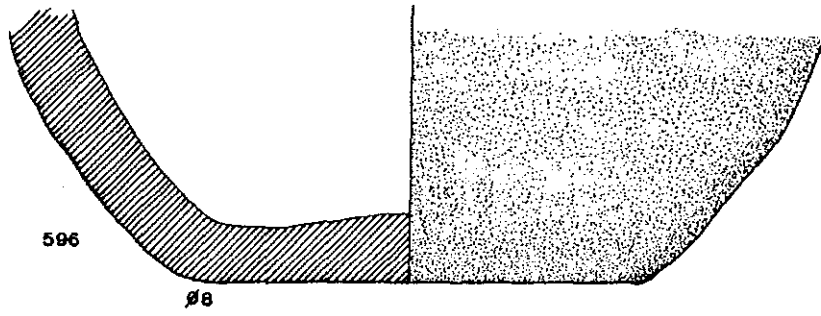

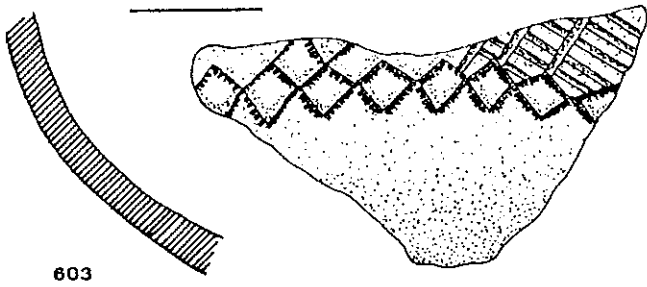

Ø 12

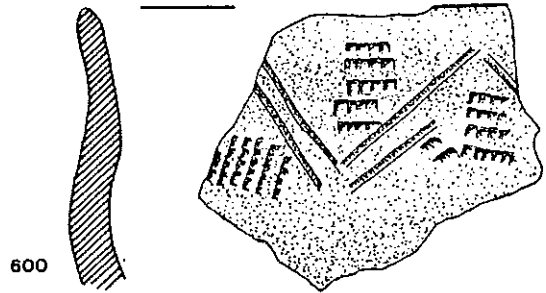

Ø 27

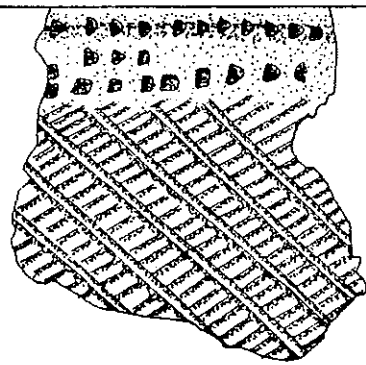
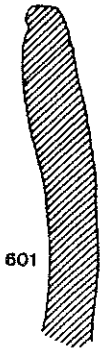

SUMBI

Ø 15

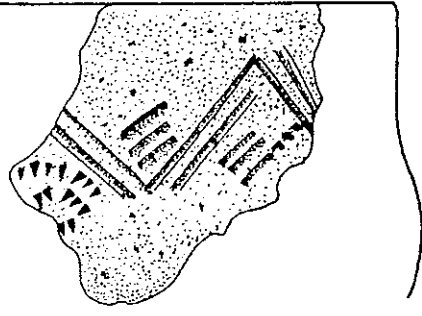
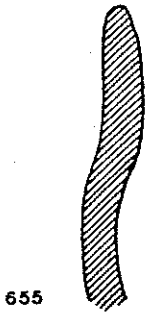

Ø 18

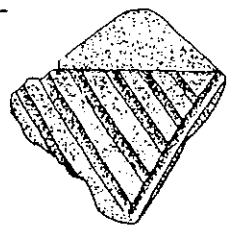
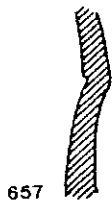
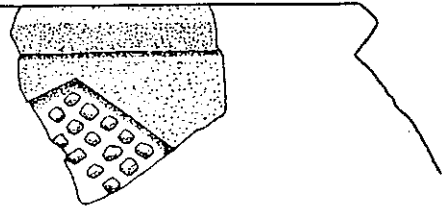
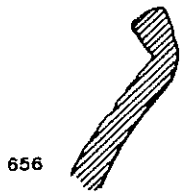

ø22

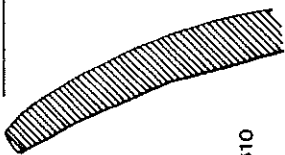

610

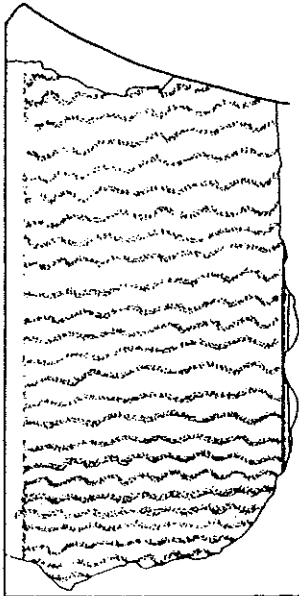

ø±30

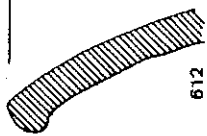

612

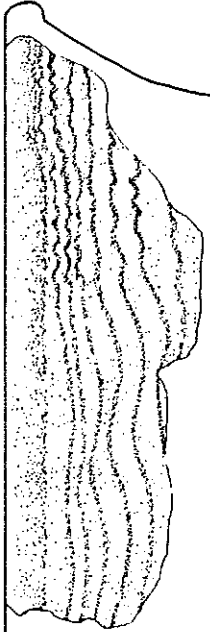

ø28



609

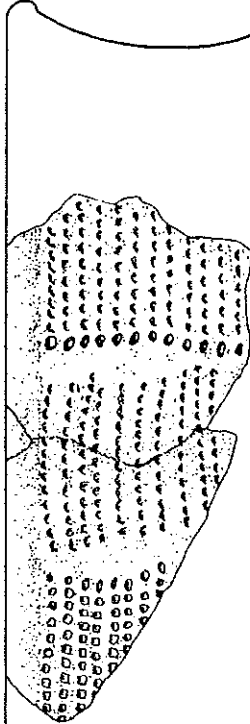

SUMBI



654



614

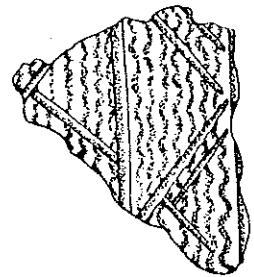

637

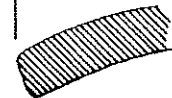
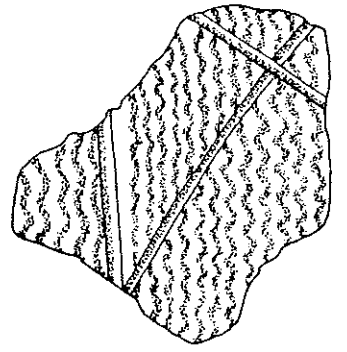

651

Ø24

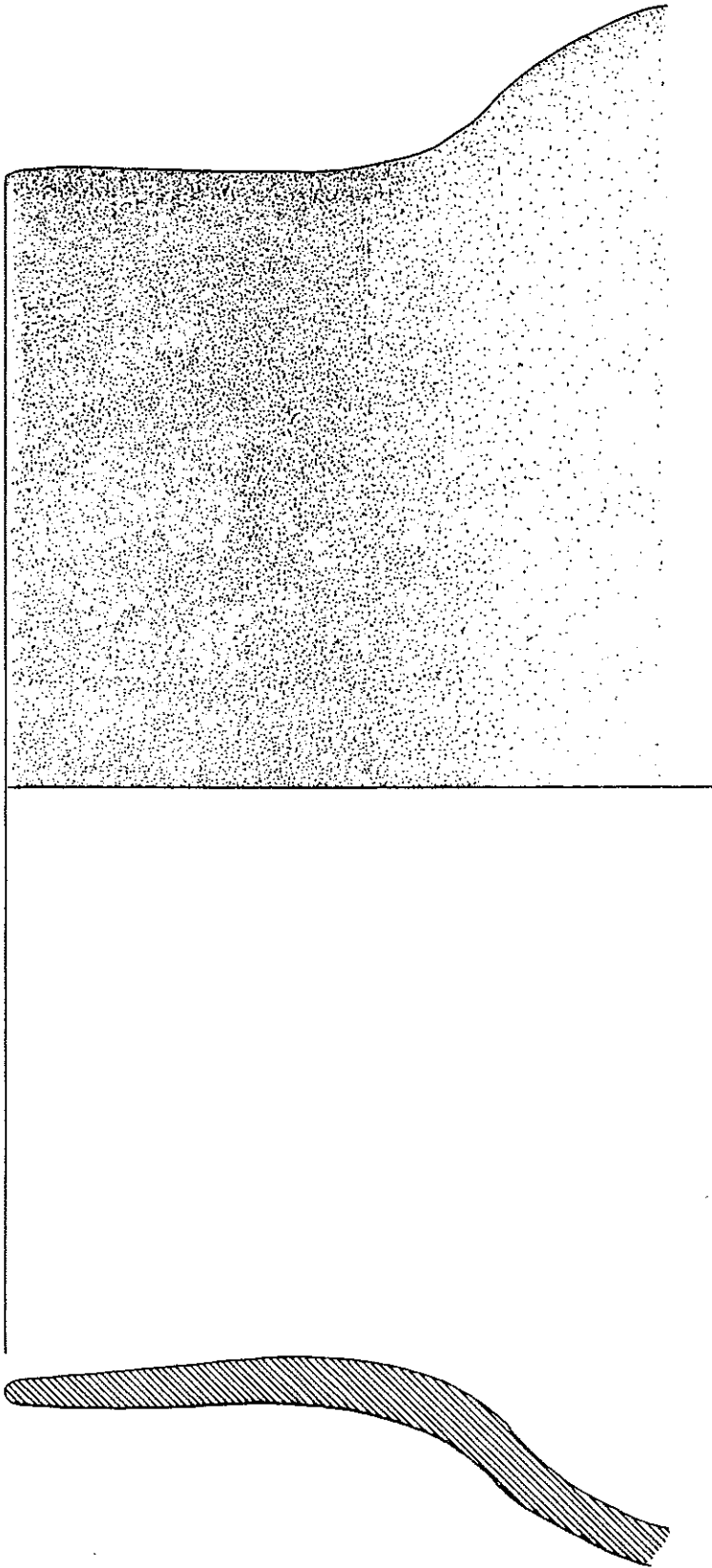

397

Ø10

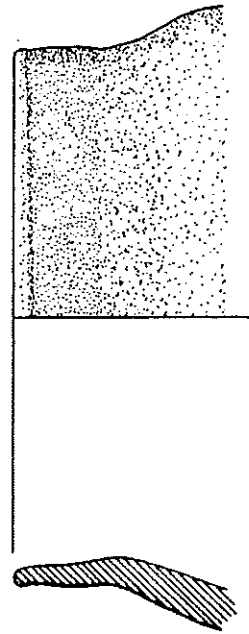

404



SUMBI

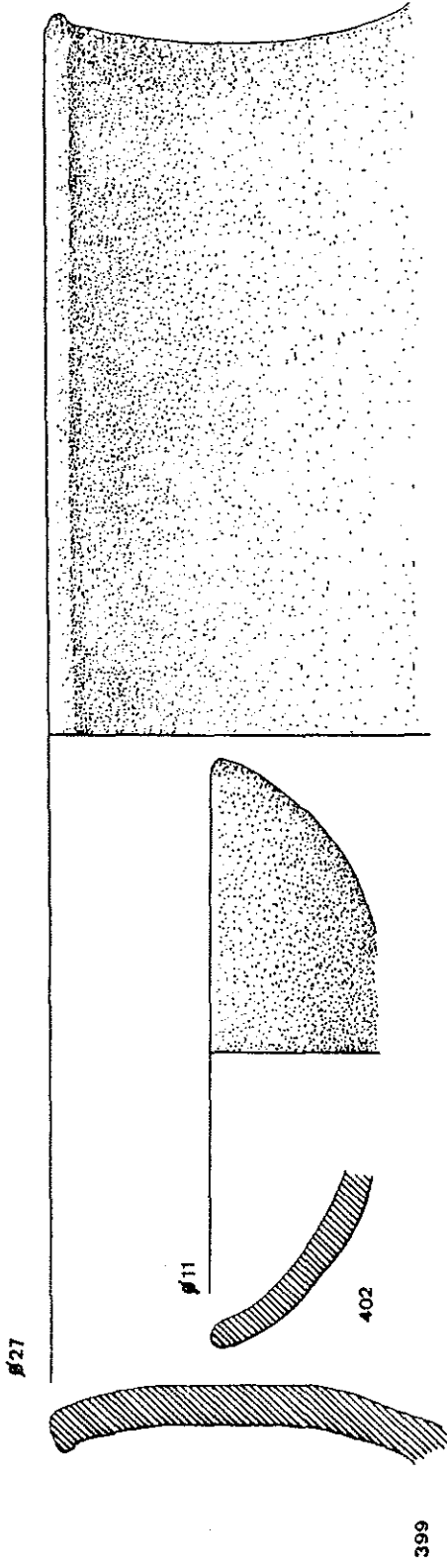

SUMBI

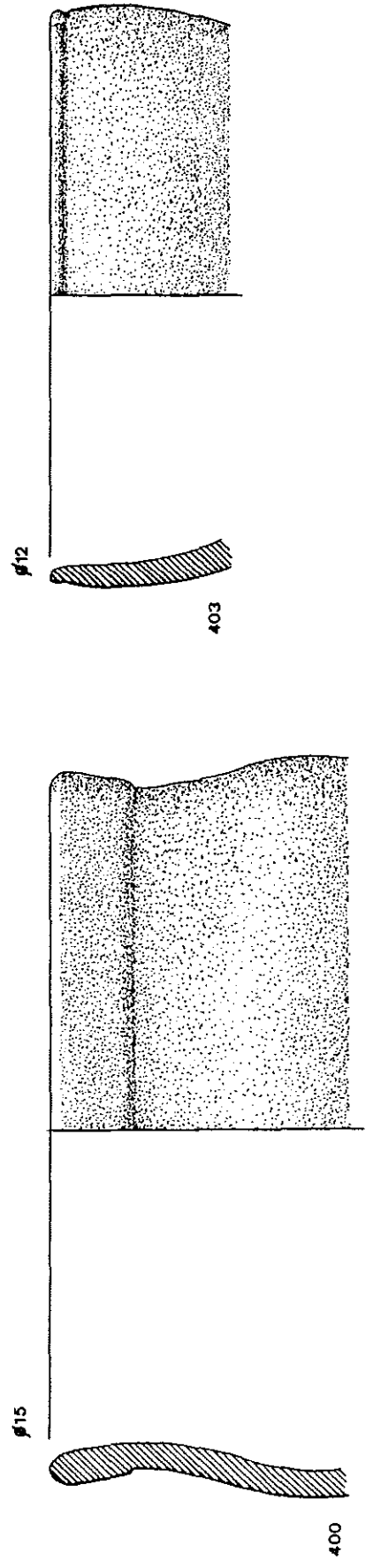
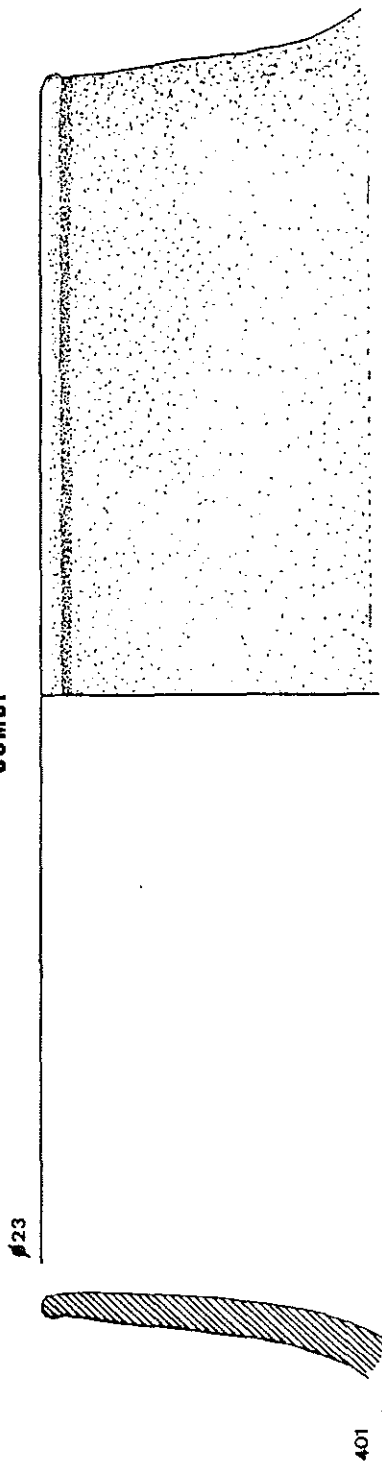

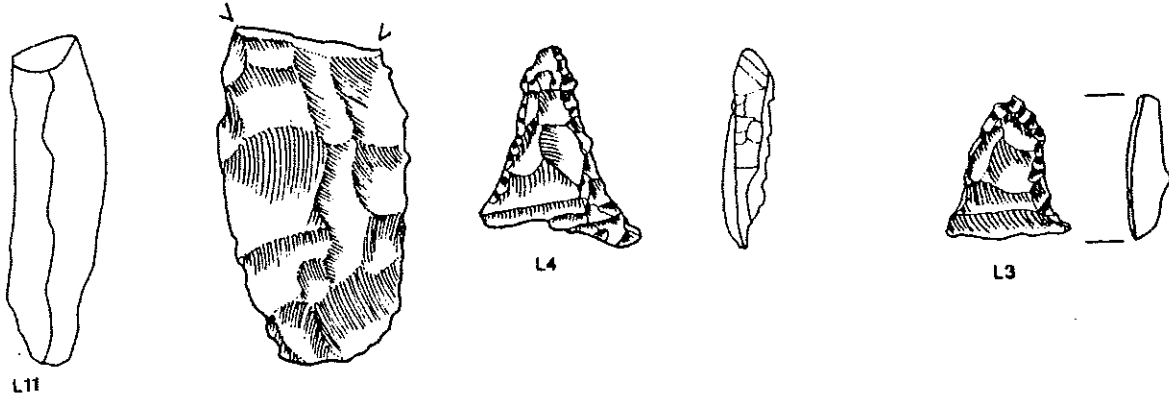

SUMBI (L11) ET MANTSETSI

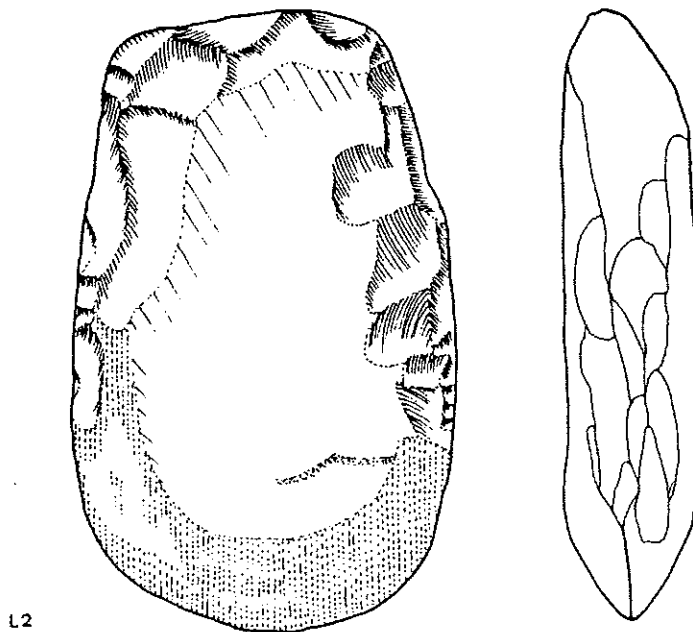
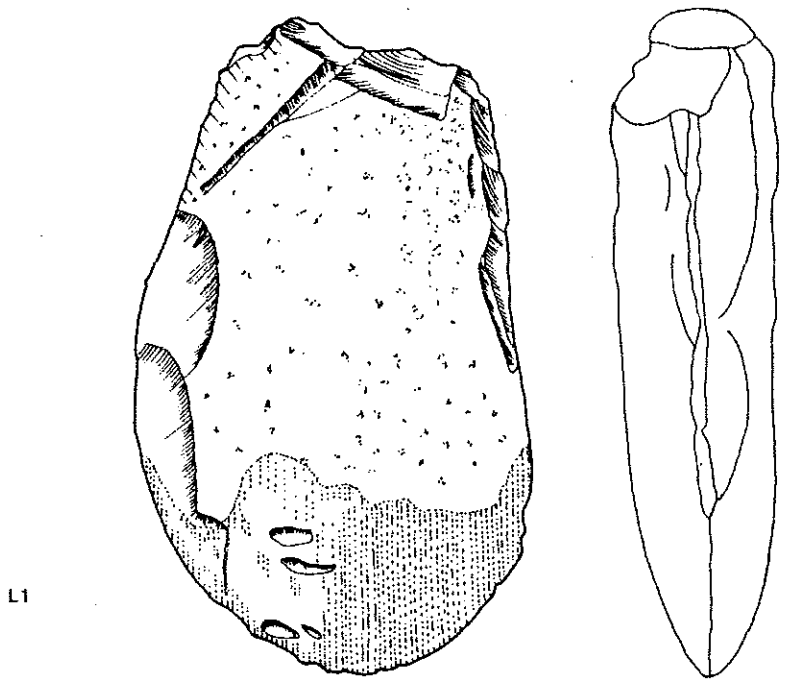

L2

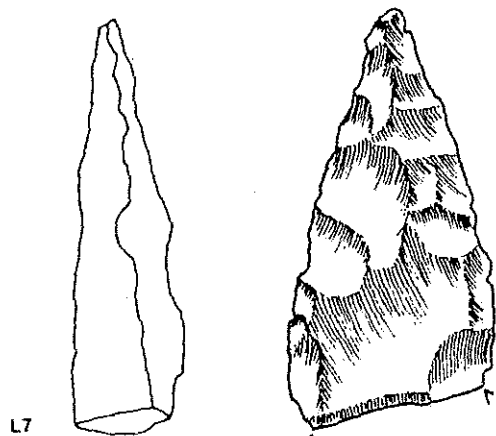
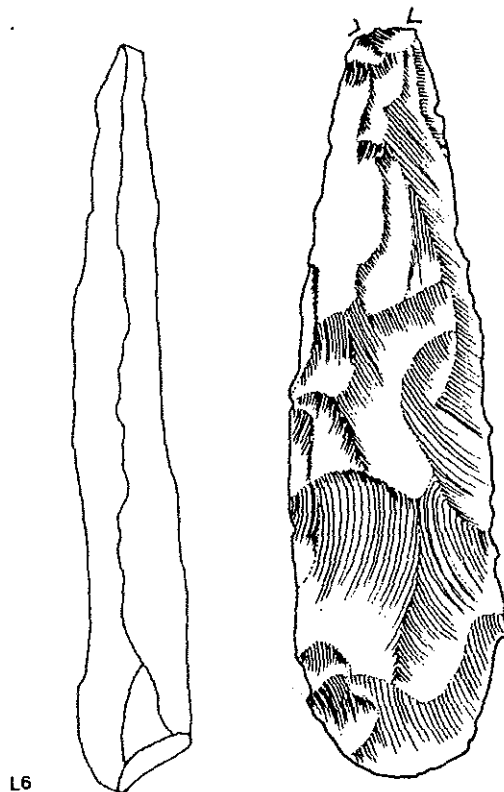
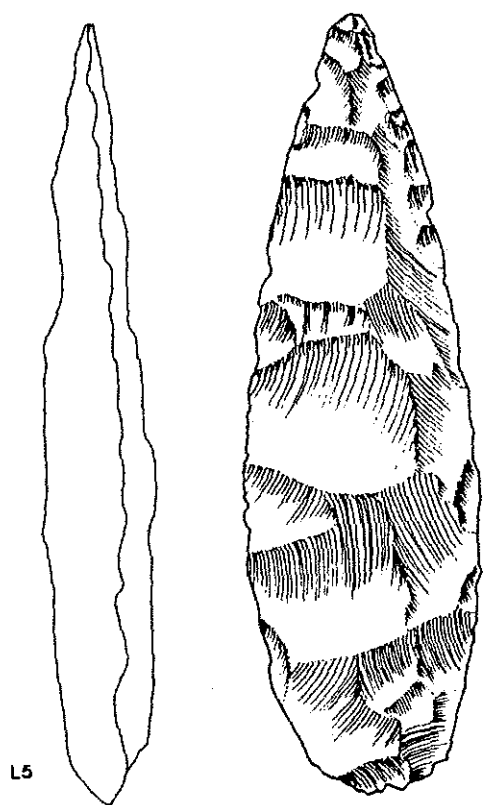

MANTSETSI

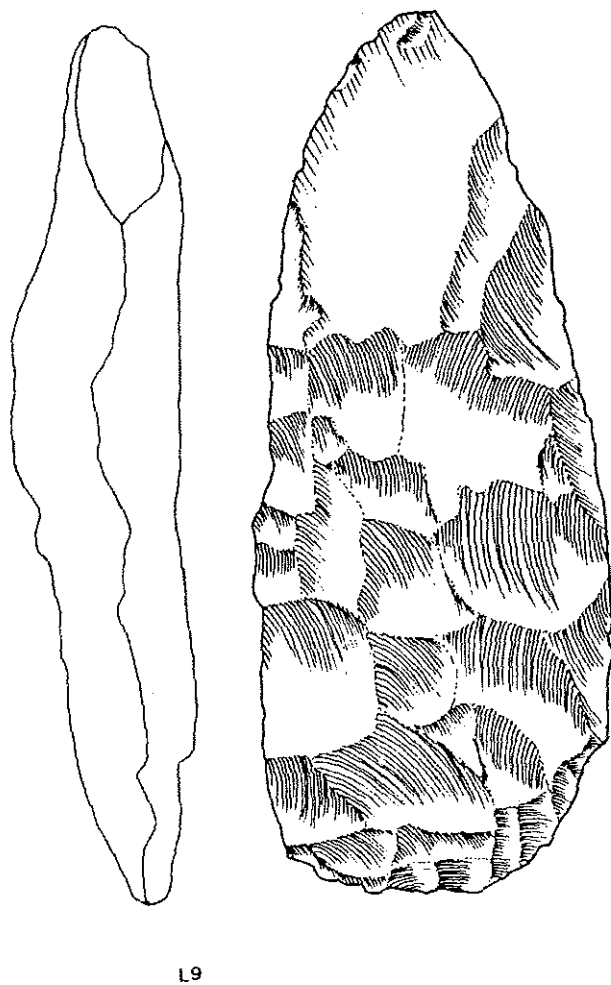
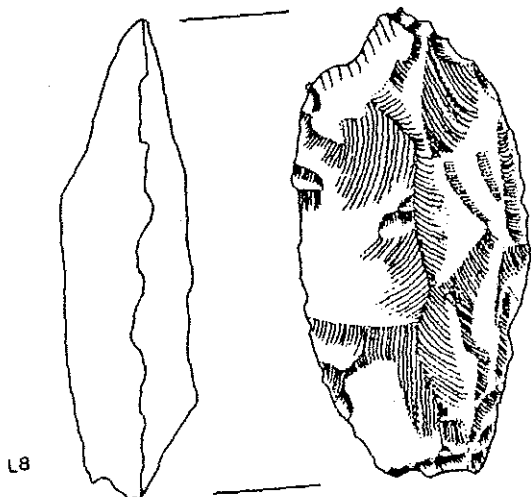

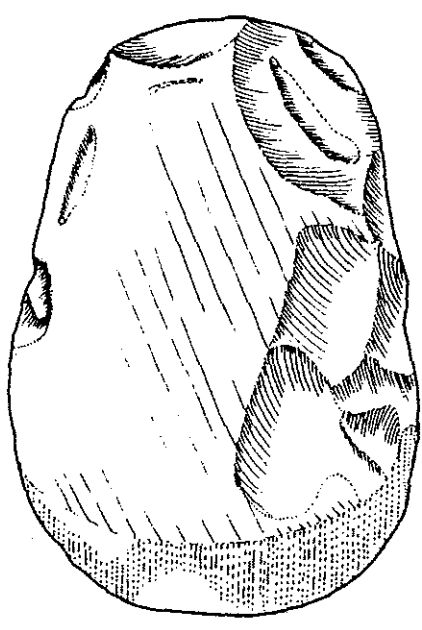

L10

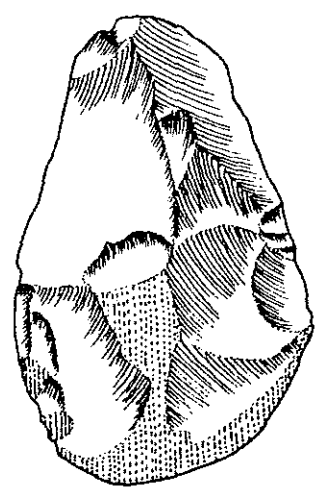
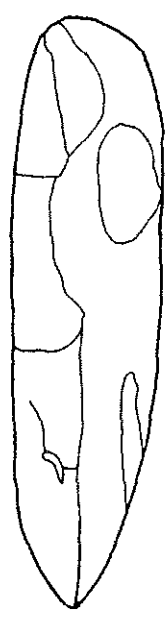

70.170

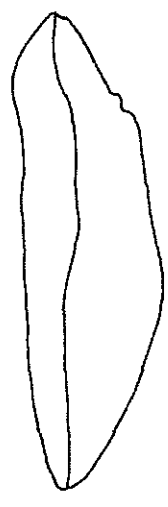

KINDU 2 (L10) ET SUNDE LUTETE

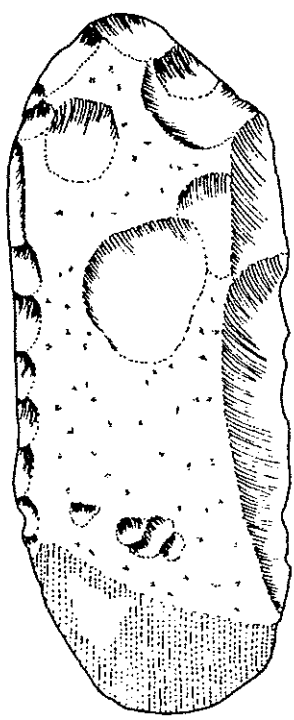

70.166

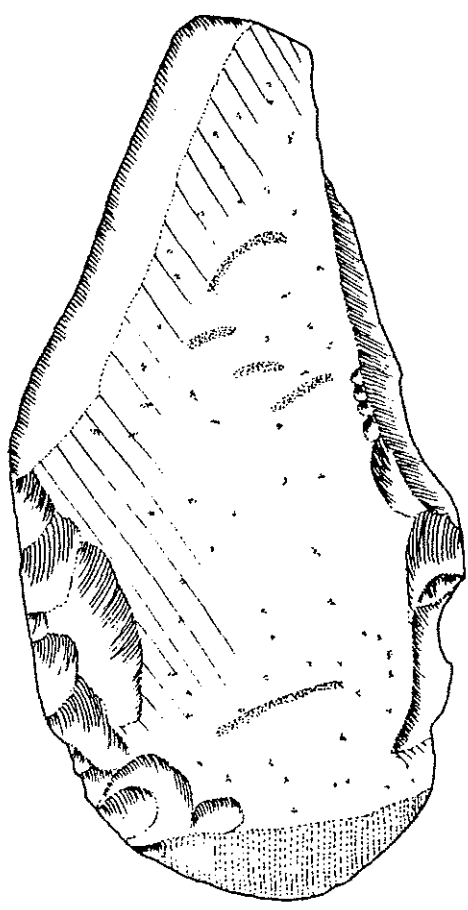
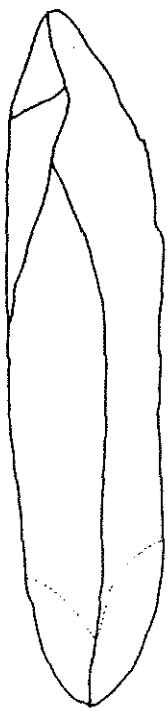

70.169

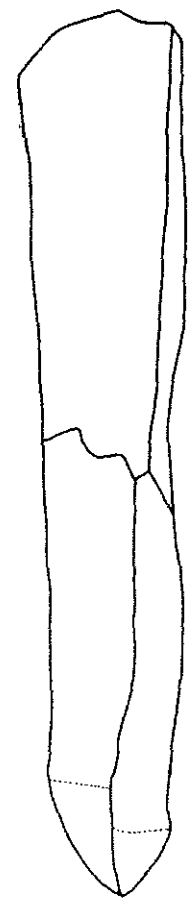

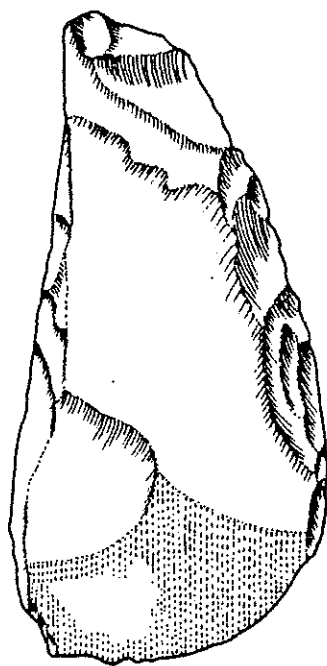
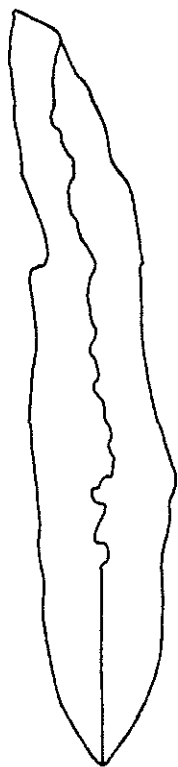
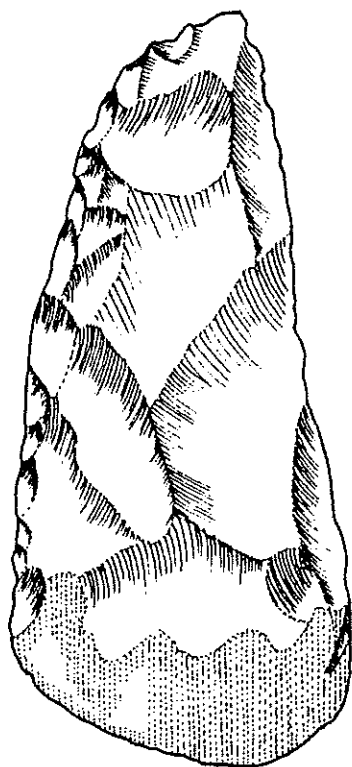

65.957 KONGO-DIA-VANGA .TWANKULU

65.956

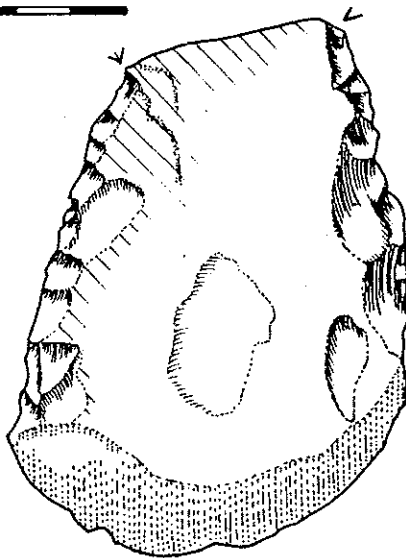
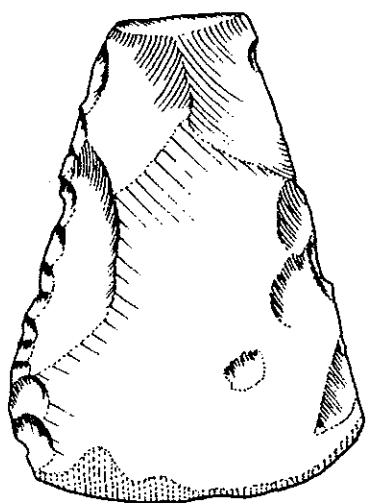

65.959

65.961

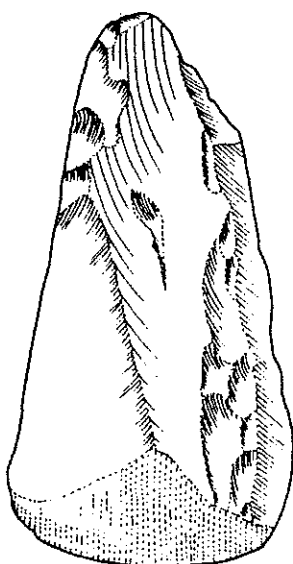

65.960

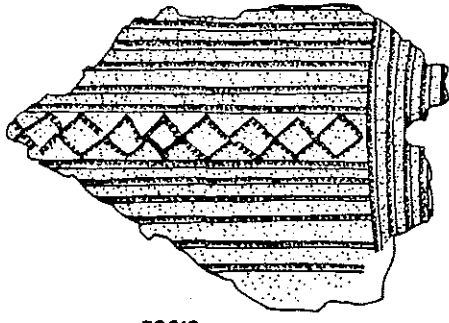

70.210



70.241

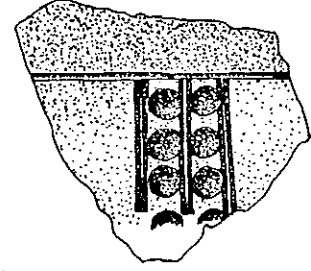

SUNDE LUTETE



70.241

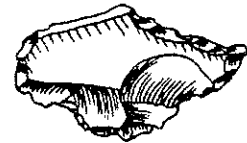
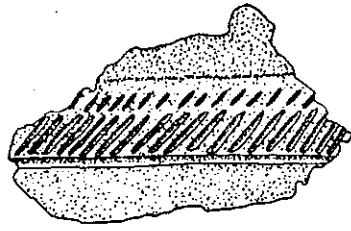

70.168-12

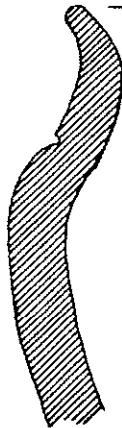
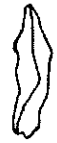

73.122-1

ø ± 16

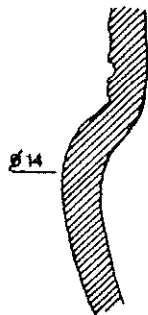
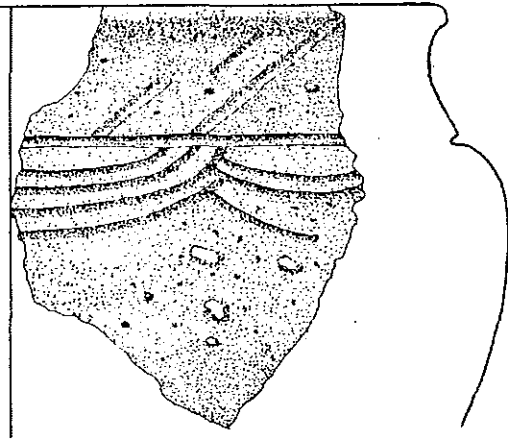

73.122-2

ø 14

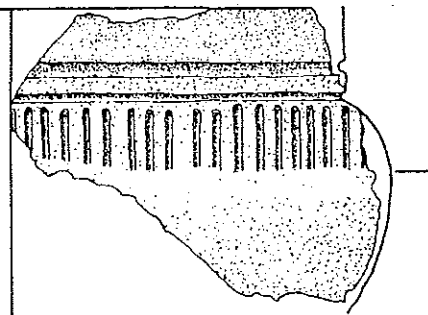

BANGU

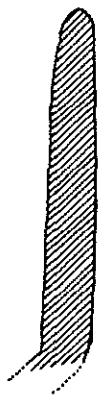

70378



70414



70404



70406



70400

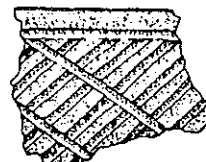

70384

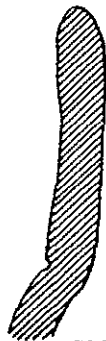
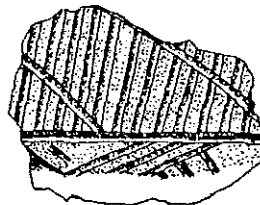

70375

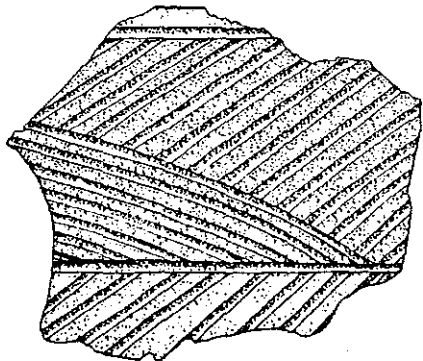

70417

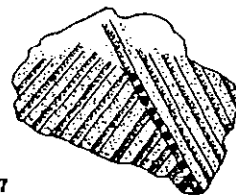

70373

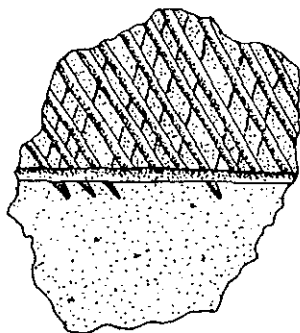

70382

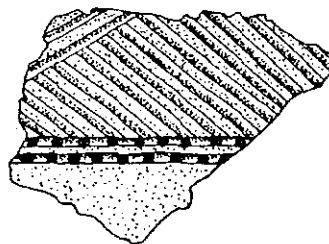

KIMBALA SOLELE

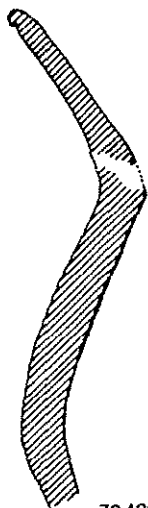

70428

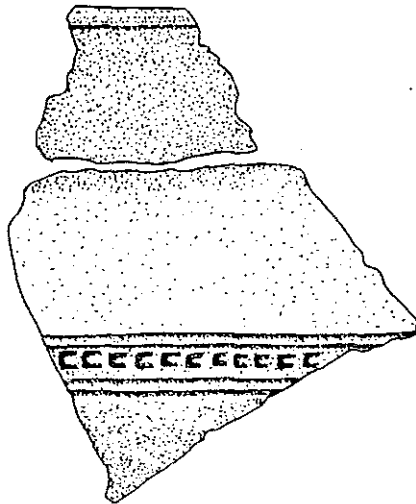

70393

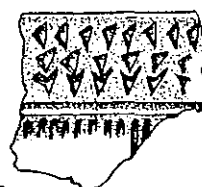

70398

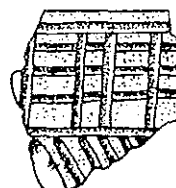

ø25



70308



70300

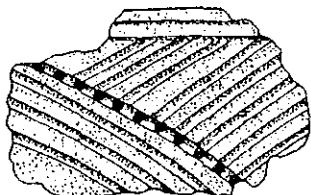

70342

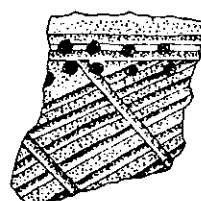

70304

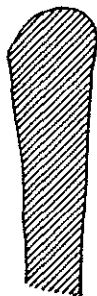
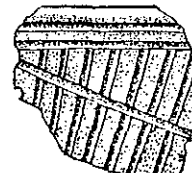

70313

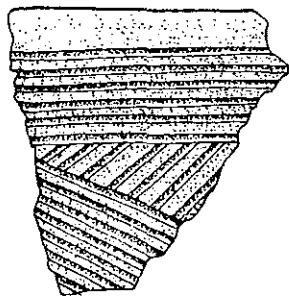

70336

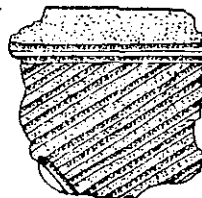

ø19

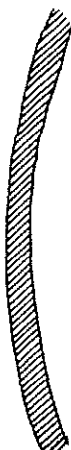

70329

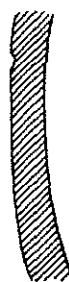
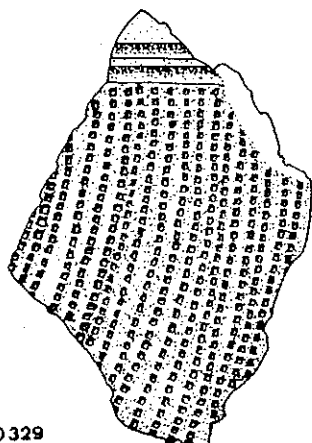

70304

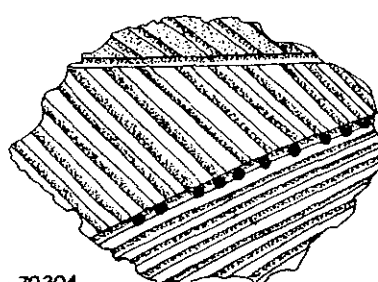

70316

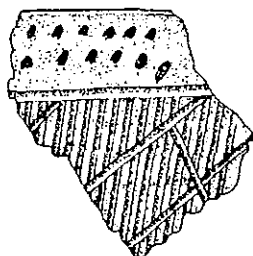

70345

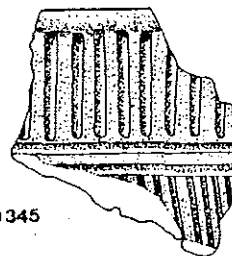

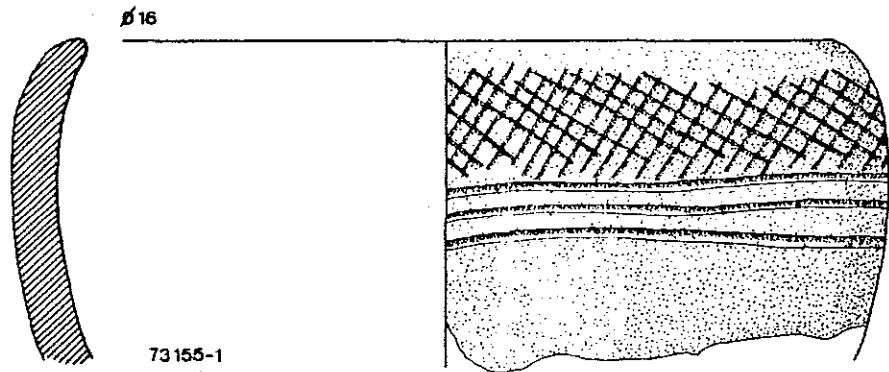
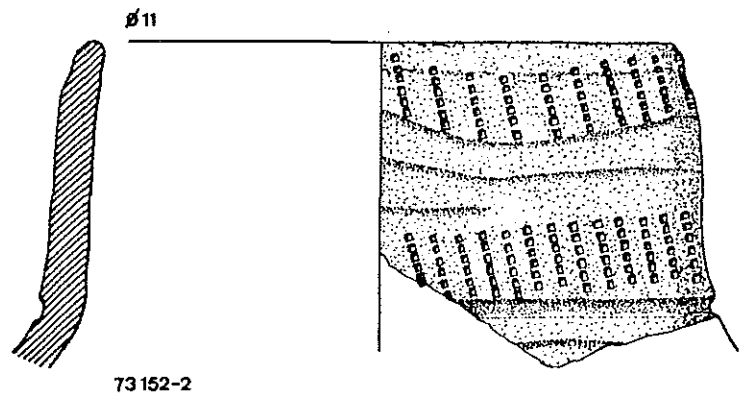
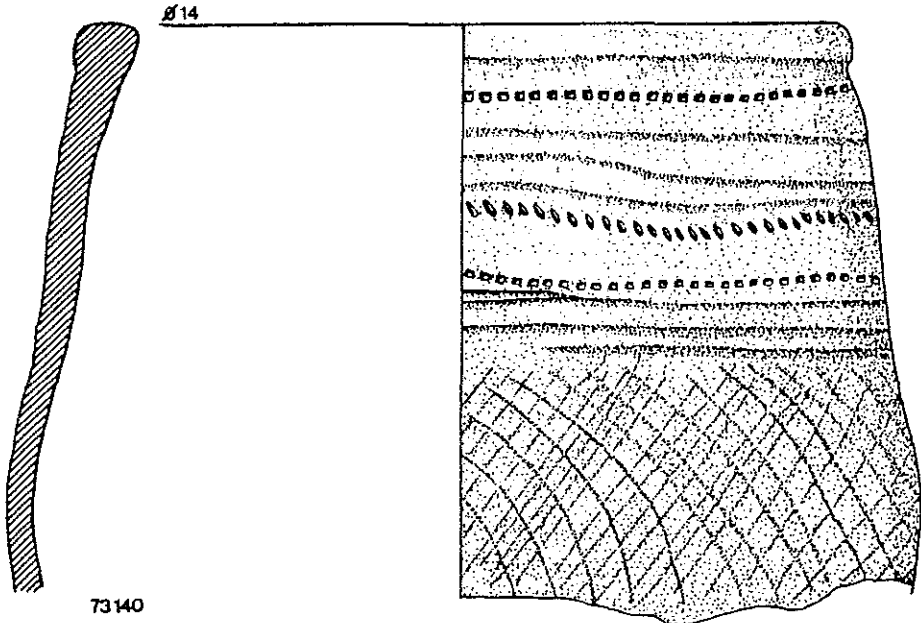

KONGO-DIA-VANGA. VILLAGE

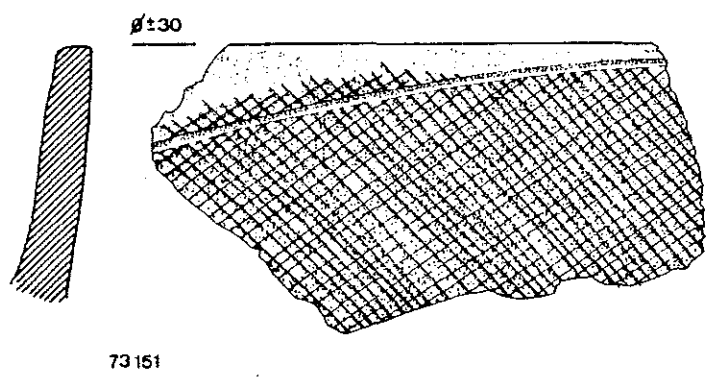

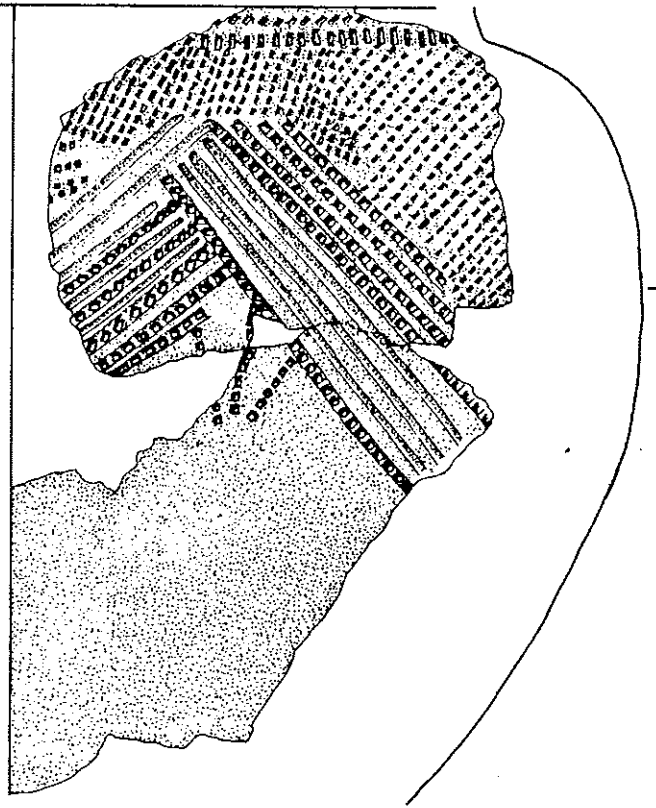
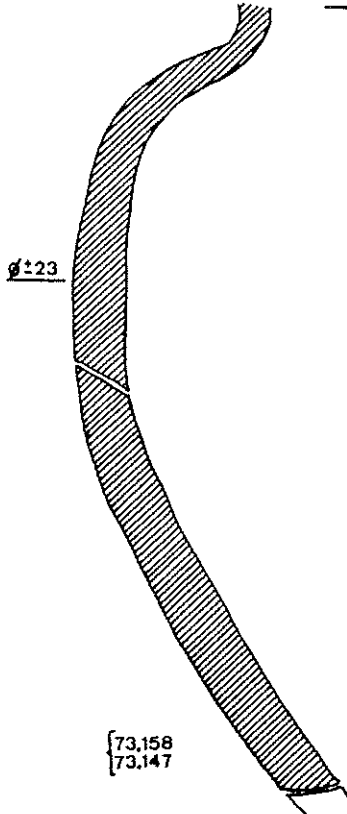

KONGO-DIA-VANGA - VILLAGE

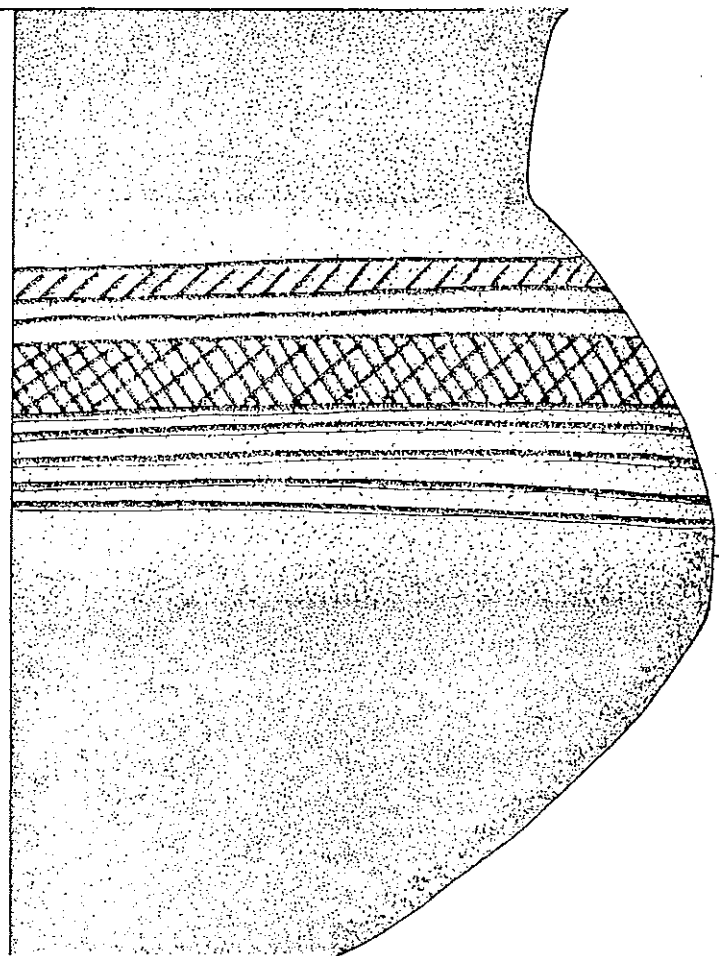
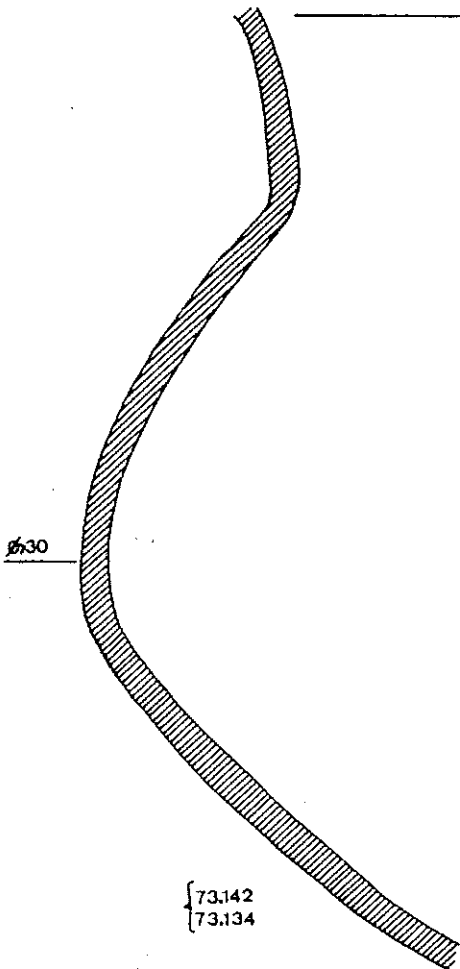

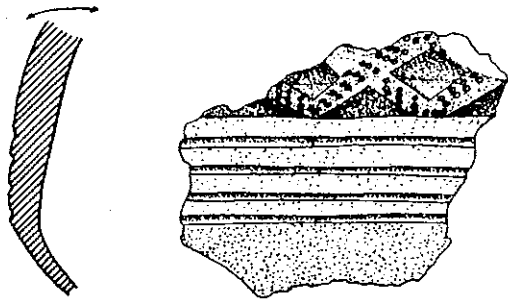

73216-4

KONGO-DIA-VANGA VILLAGE, 1

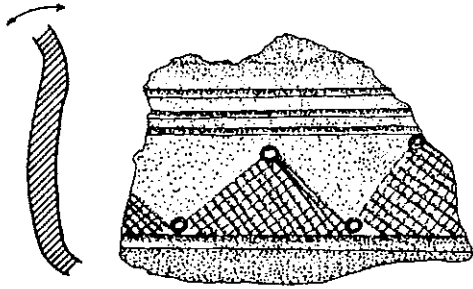

73216-3

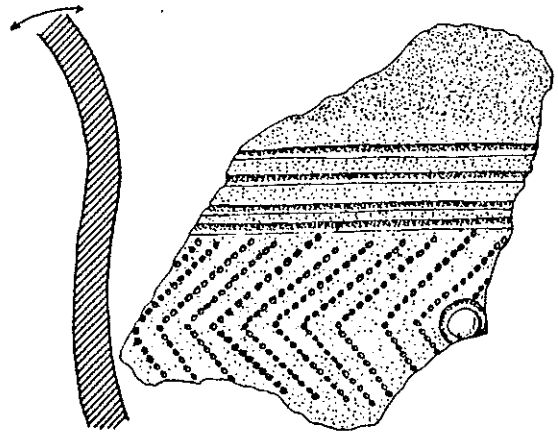

73216-2,5

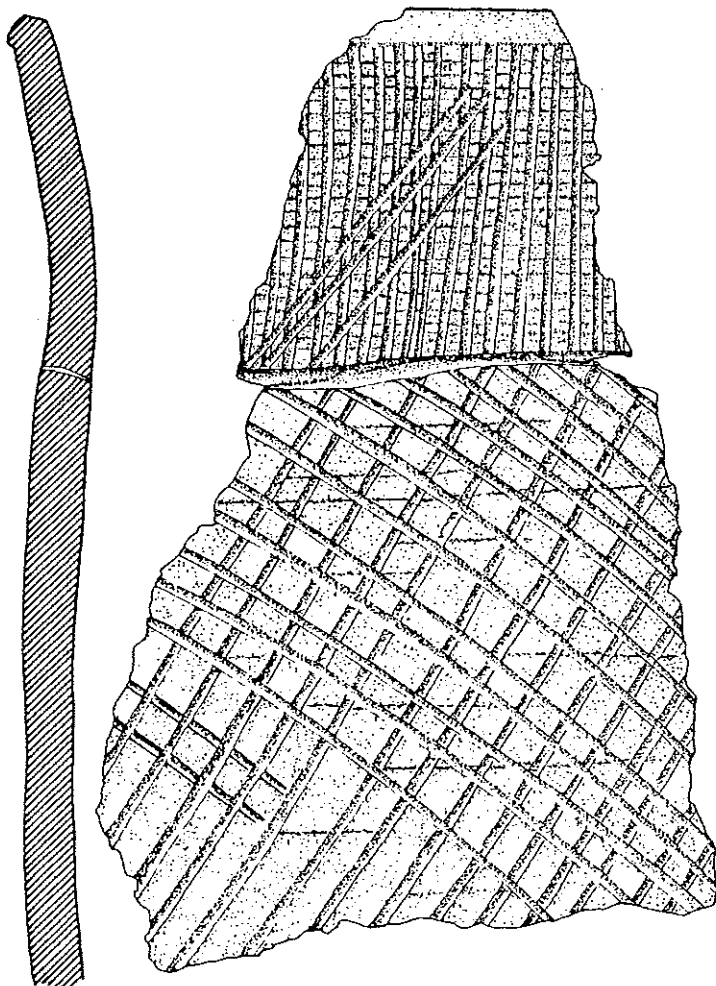

73214

KONGO-DIA-VANGA VILLAGE, 2

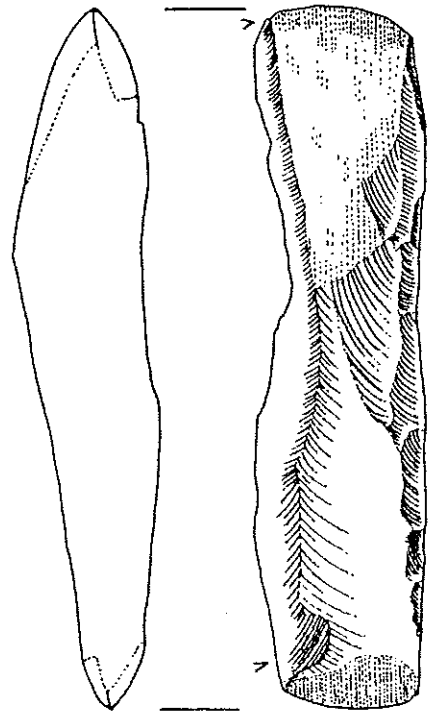

73179

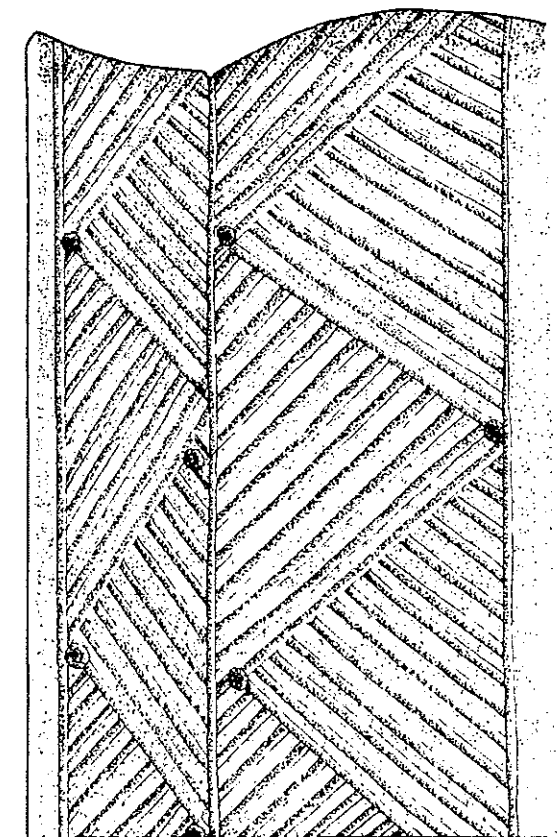

1/30

73207

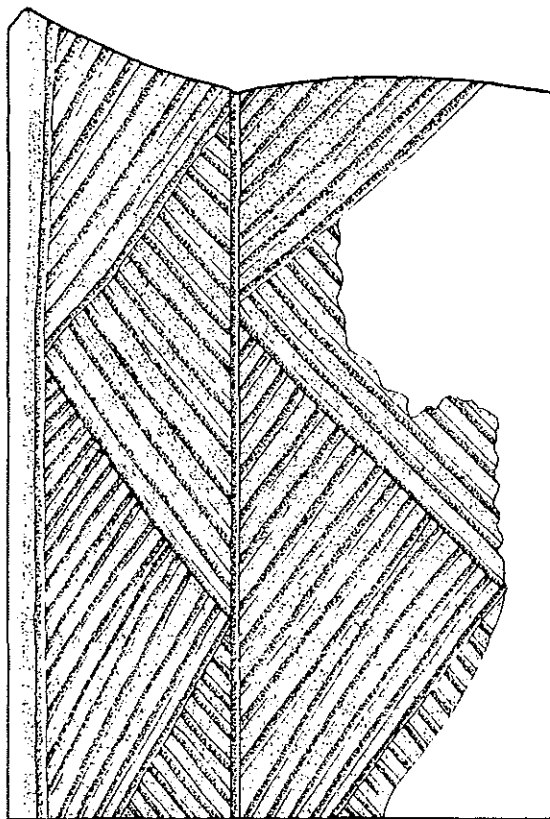

1/30

73212



KONGO-DIA-YANGA-VILLAGE, 2

ø16

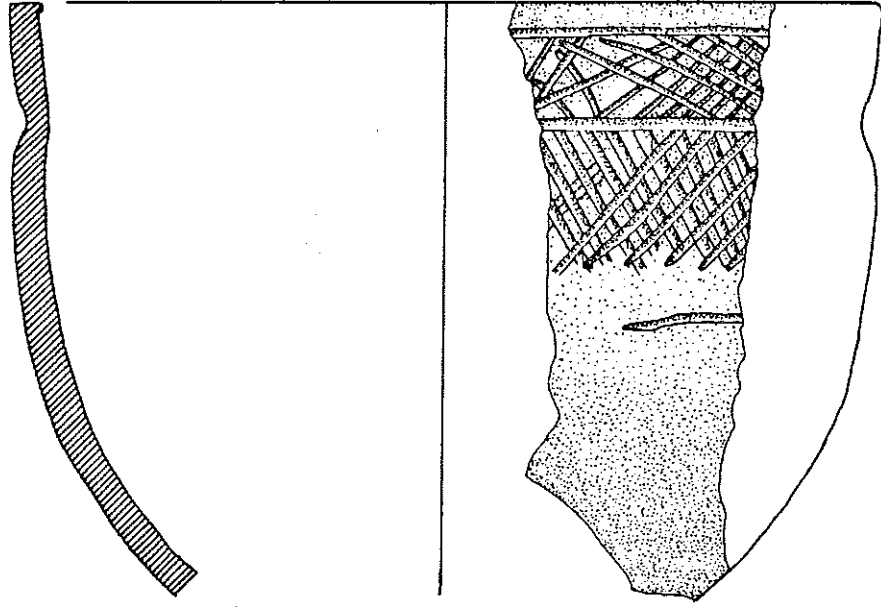

73226

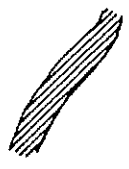

73223

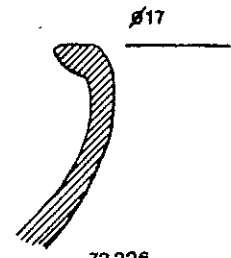
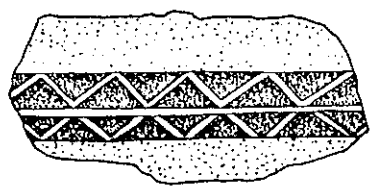

73226

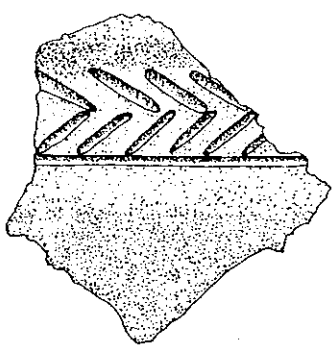

73226

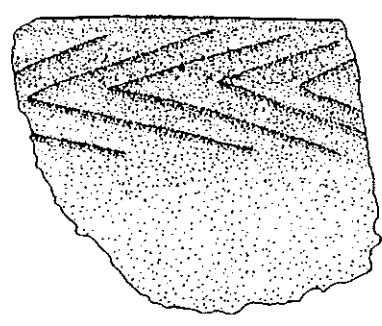

KONGO - DIA-VANGA. SITE B

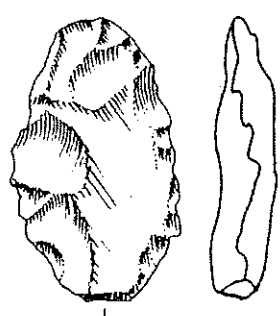

65 889

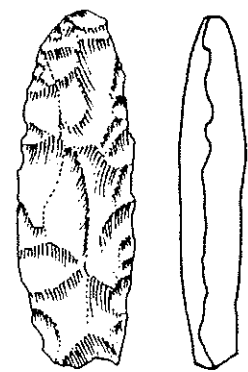

65 893

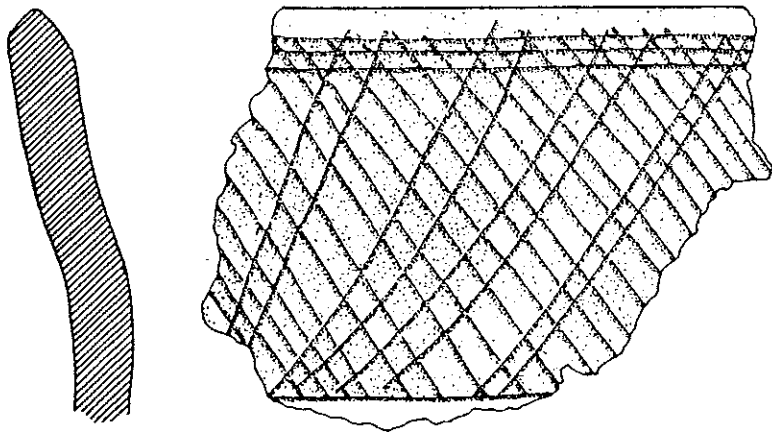

62.787 D



TUMBA

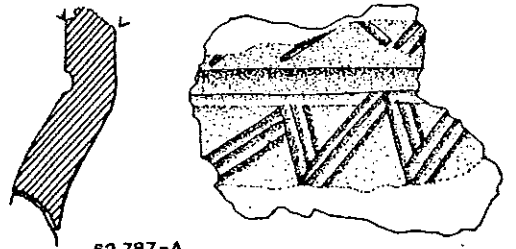

62.787-A

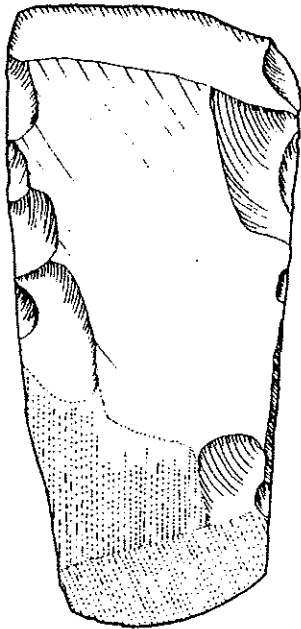

70.784

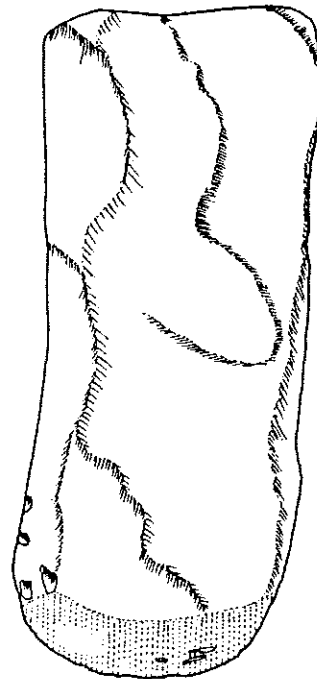
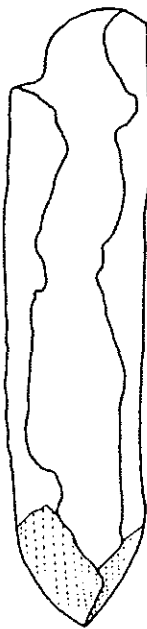

70.785



KIBANZA